



JARO THERMAL

SPECIFICATION FOR APPROVAL

Customer :
Customer Part No. :
Description : Thermal module
JARO Model No. : JSC00151 REV.0
Sample Issue No. :
Sample Issue Date :
 Preliminary Specification
 Formal Specification

PREPARED BY :	Sidney Li	DATE :	11/15/2023
CHECKED BY :	Chris Hsu	DATE :	11/15/2023
APPROVED BY :	Chris Hsu	DATE :	11/15/2023

PLEASE SEND ONE COPY OF THIS SPECIFICATION BACK AFTER YOU SIGNED APPROVAL FOR PRODUCTION PRE-ARRANGEMENT.

By: _____ (printed)

Signature: _____

Date: _____



Jaro Thermal USA office
6600 Park of Commerce Blvd.
Boca Raton, Florida 33487
www.jarothermal.com
Ph: 561-241-6700
Fx: 561-241-3328

Jaro Thermal Taiwan office
Building H, No.119-1, Zhudong Rd., Renwu
Dist., Kaohsiung City, Taiwan 81448
www.jarothermal.com
Ph: +886-7-375-2053
Fx: +886-7-374-7403

We keep the world cool™



JARO MODEL NUMBER

JSC00151



Revision of Spec History

Revision	Change Content	Change page	DATE	BY
0	Created SPEC		11/15/2023	Sidney Li

Notice:

1. This specification will be changed base on Jaro Thermal 's notification. Please refer to update revision of spec by contacting Jaro Thermal.
2. This specification clarify all the mechanical & electrical characteristics of DC brushless fans & AC brushless fans & heat sink.
3. The specification of this product is described in detailed document. Please do not use the fan without proper usage. Please contact Jaro Thermal if you have special requirement which is not listed on this specification.
4. Any of change, please contact Jaro Thermal to change the new revision in order to make sure all technical data is up to date. Any ECN change will be followed by sending new update specification.

1. Assembly drawing

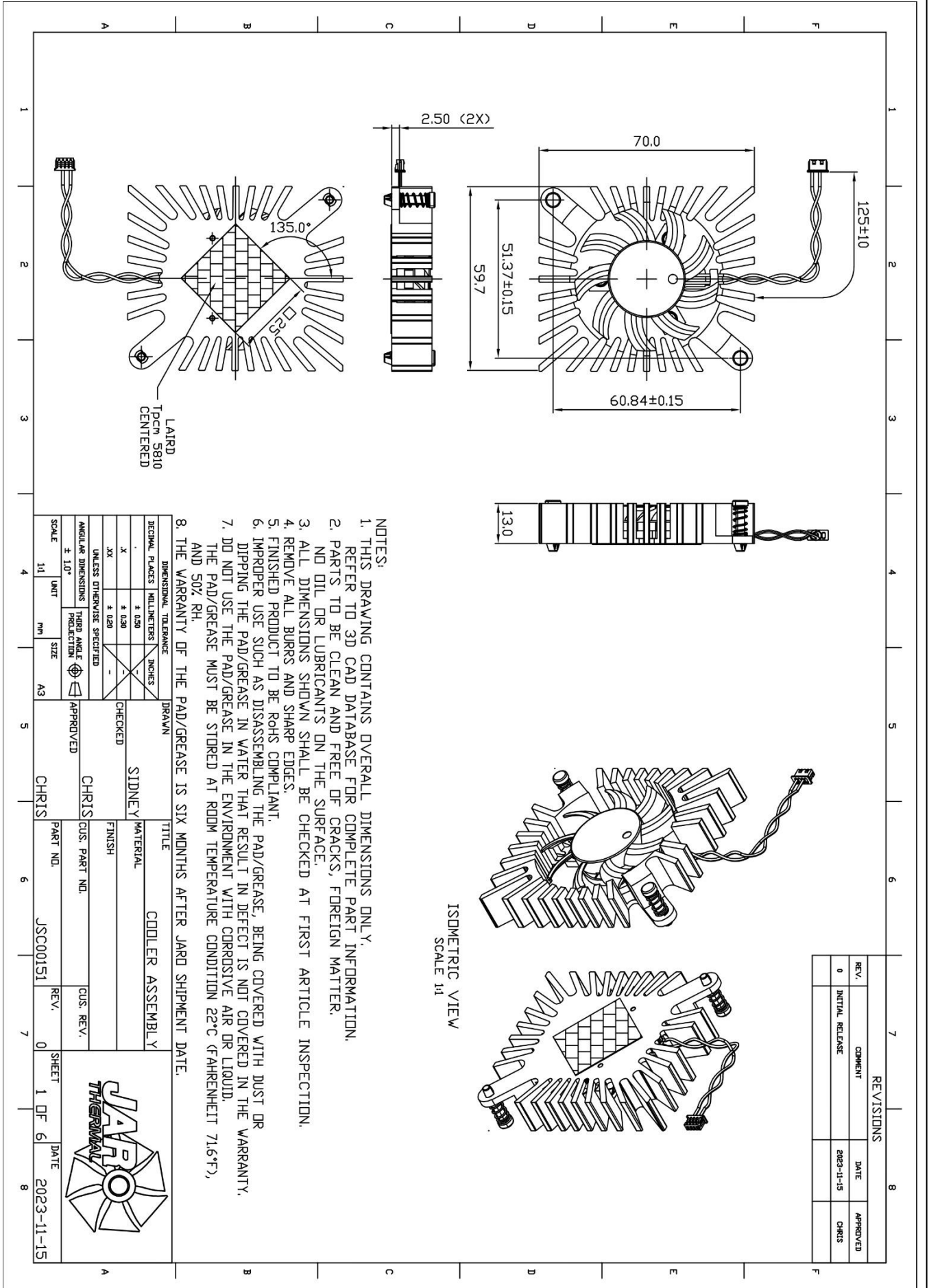

REVISIONS			
REV.	COMMENT	DATE	APPROVED
0	INITIAL RELEASE	2023-11-15	CHRIS

DIMENSIONAL TOLERANCE		DRAWN		TITLE	
DECIMAL PLACES	MILLIMETERS	INCHES		COOLER ASSEMBLY	
X	± 0.50	X			
.XX	± 0.20	-			
UNLESS OTHERWISE SPECIFIED					
ANGULAR DIMENSIONS	THIRD ANGLE PROJECTION				
± 10°					
SCALE	UNIT	SIZE			
1:1	MM	A3			
			CHECKED		
			APPROVED		
			SIDNEY Y.		
			CHRIS		
			CHRIS		
			PART NO.		
			JSC00151		
			REV.		
			0		
			SHEET		
			1 OF 6		
			DATE		
			2023-11-15		



2. Exploded views

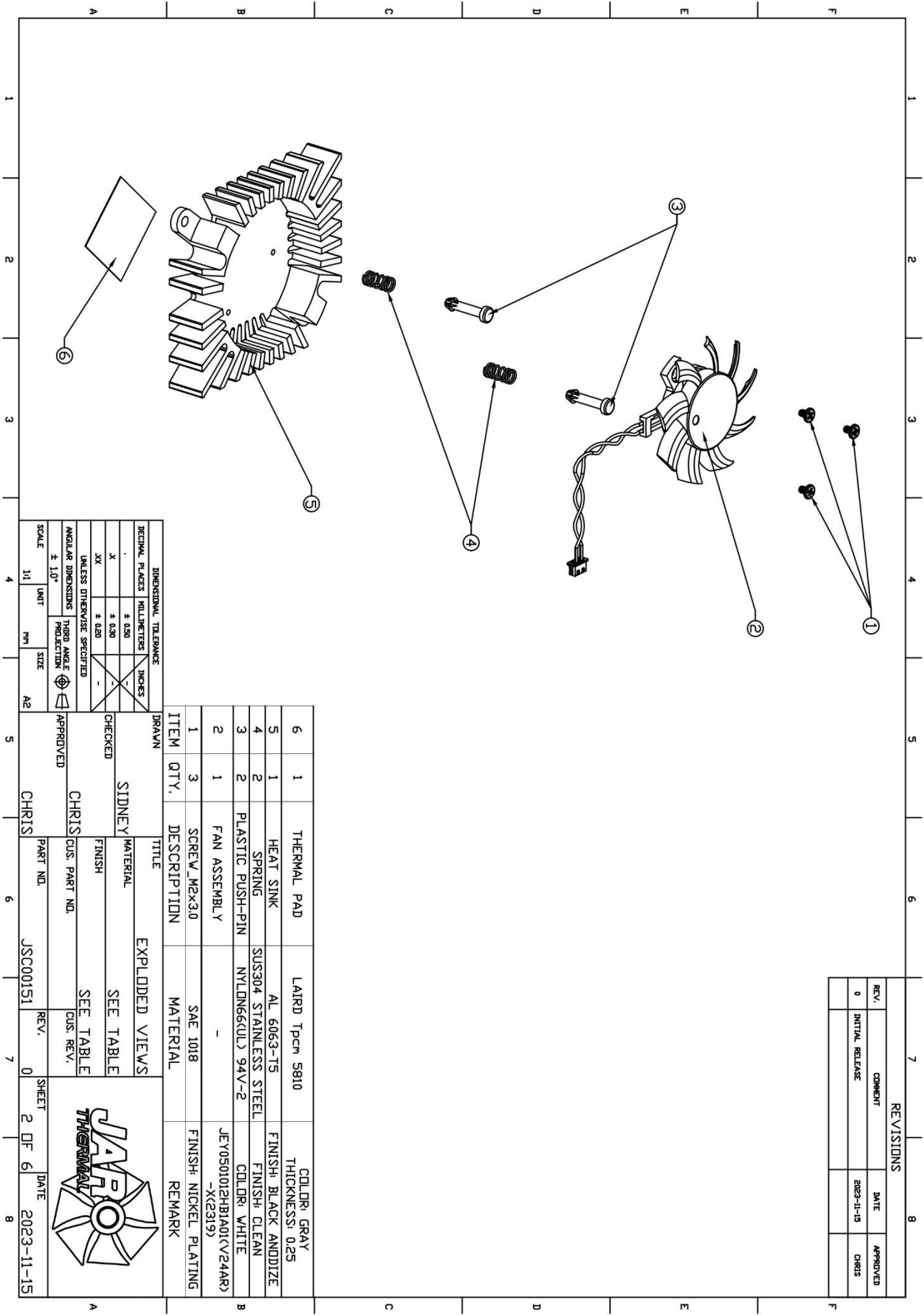

REVISIONS			
REV.	COMMENT	DATE	APPROVED
0	INITIAL RELEASE	08/2-11-15	CHRIS

ITEM	QTY.	DESCRIPTION	MATERIAL	FINISH	REMARK
1	3	SCREW_M2x3.0	SAE 1018		FINISH: NICKEL PLATING
2	1	FAN ASSEMBLY			
3	1	PLASTIC PUSH-PIN	NYLON66(UL) 94V-2		JEY0501012HBIAD1(V24AR) -XC2319)
4	2	SPRING	SUS304 STAINLESS STEEL		FINISH: CLEAN
5	1	HEAT SINK	AL 6063-T5		FINISH: BLACK ANODIZE
6	1	THERMAL PAD	LAIRD Tpcm 5810		COLD PL. GRAY THICKNESS: 0.25

DIMENSIONAL TOLERANCE			
DECIMAL PLACES	MILLIMETERS	INCHES	
.X	± 0.50	-	
.XX	± 0.30	-	
.XXX	± 0.20	-	

UNLESS OTHERWISE SPECIFIED		THIRD ANGLE PROJECTION	
ANGULAR DIMENSIONS	± 10°	APPROVED	CHRIS
CHECKED	SIDNEY	PART NO.	JSC00151
FINISH	SEE TABLE	REV.	0
CUS. PART NO.	SEE TABLE	SHEET	2 OF 6
CUS. REV.	SEE TABLE	DATE	2023-11-15

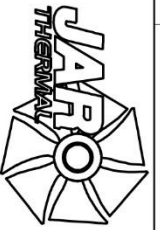

3. Individual component drawing

1) Heat sink

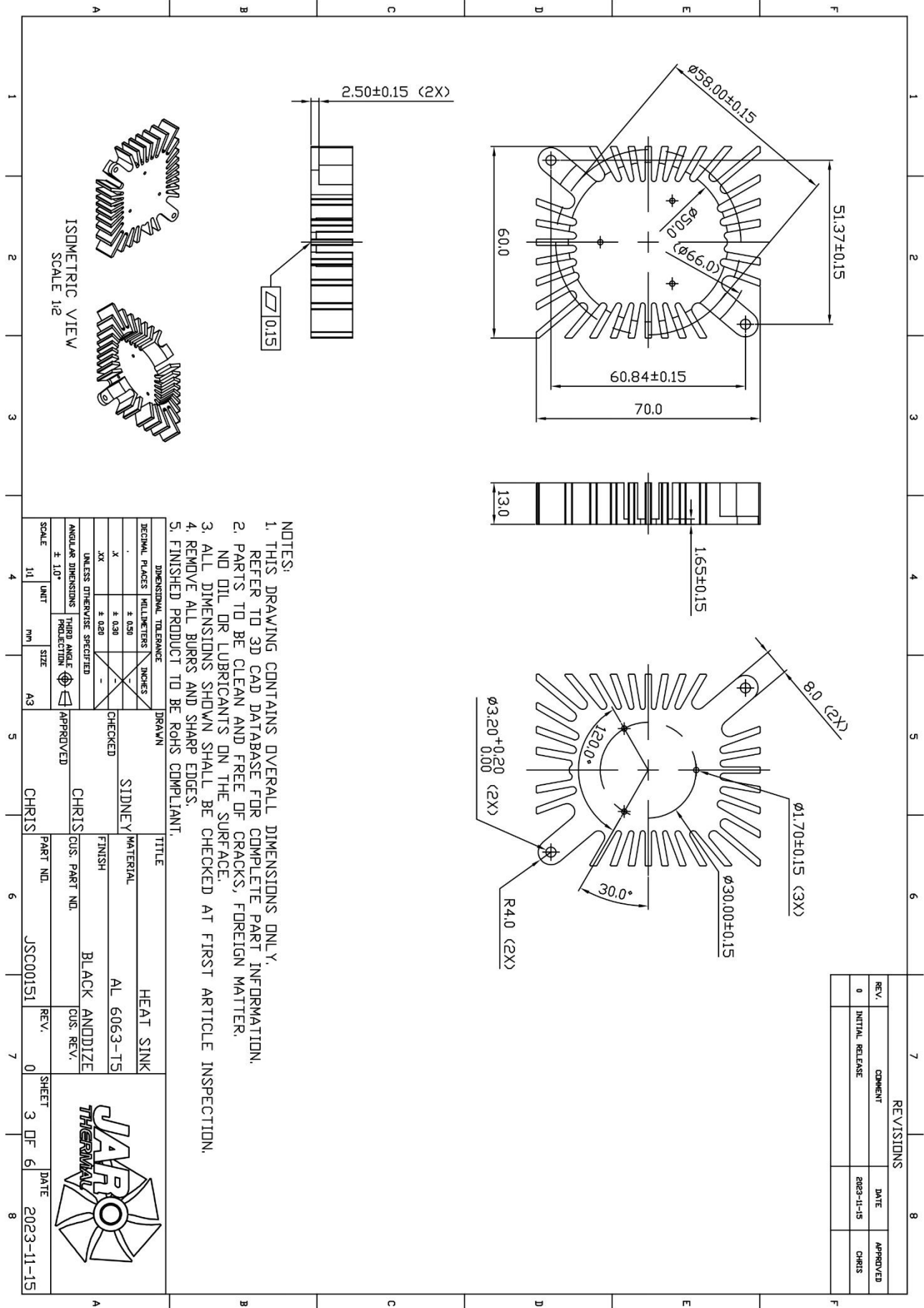

- NOTES:
1. THIS DRAWING CONTAINS OVERALL DIMENSIONS ONLY. REFER TO 3D CAD DATABASE FOR COMPLETE PART INFORMATION.
 2. PARTS TO BE CLEAN AND FREE OF CRACKS, FOREIGN MATTER, NO OIL OR LUBRICANTS ON THE SURFACE.
 3. ALL DIMENSIONS SHOWN SHALL BE CHECKED AT FIRST ARTICLE INSPECTION.
 4. REMOVE ALL BURRS AND SHARP EDGES.
 5. FINISHED PRODUCT TO BE ROHS COMPLIANT.

REVISIONS			
REV.	COMMENT	DATE	APPROVED
0	INITIAL RELEASE	2023-11-15	CHRIS

DIMENSIONAL TOLERANCE		TITLE	
DECIMAL PLACES	MILLIMETERS	INCHES	
.X	± 0.50	-	SIDNEY
.XX	± 0.20	-	CHECKED
UNLESS OTHERWISE SPECIFIED		APPROVED	
ANGULAR DIMENSIONS THIRD ANGLE PROJECTION		CHRIS	
SCALE $\pm 1.0^\circ$		CUS. PART NO.	
1:1	MM	A3	CHRIS

MATERIAL		HEAT SINK	
FINISH		AL 6063-T5	
PART NO.		BLACK ANODIZE	
JSC00151		CUS. REV.	
REV.	0	SHEET	3 OF 6
DATE		2023-11-15	

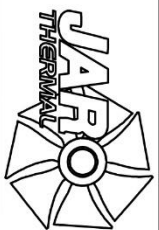

2) Plastic push-pin assembly

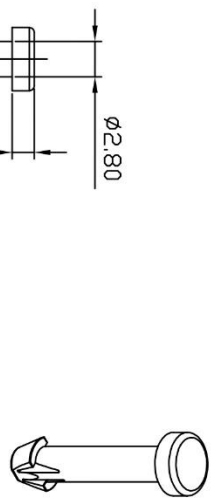
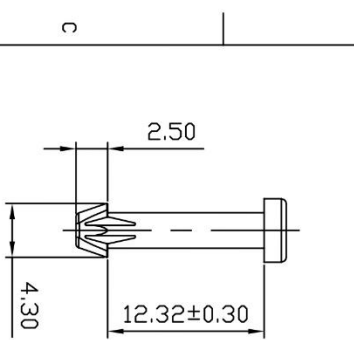
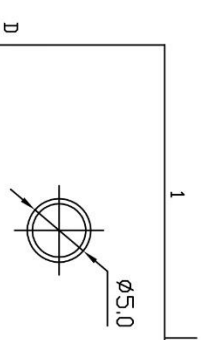

ISOMETRIC VIEW
SCALE 2:1

REVISIONS			
REV.	COMMENT	DATE	APPROVED
0	INITIAL RELEASE	2023-11-15	CHRIS

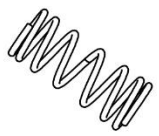
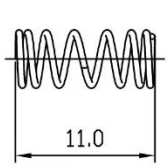
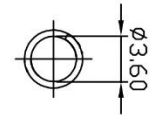

ISOMETRIC VIEW
SCALE 2:1

NOTES FOR SPRING:
 1. FREE LENGTH: 11.0mm
 2. WIRE DIAMETER: 0.5±0.05mm
 3. DD: 4.60mm
 4. ACTIVE COILS: 5, TOTAL COILS: 7
 5. SPRING RATE: 0.1655 kgf/mm ± 10%
 6. MATERIAL: SUS304 STAINLESS STEEL
 7. FINISH: CLEAN
 8. ALL DIMENSIONS SHOWN SHALL BE CHECKED AT FIRST ARTICLE INSPECTION.
 9. FINISHED PRODUCT TO BE ROHS COMPLIANT.

NOTES FOR PLASTIC PUSH-PIN (HSR-30):
 1. MATERIAL: NYLON66(UL) 94V-2
 2. COLOR: WHITE
 3. THIS DRAWING CONTAINS OVERALL DIMENSIONS ONLY. REFER TO 3D CAD DATABASE FOR COMPLETE PART INFORMATION.
 4. ALL DIMENSIONS SHOWN SHALL BE CHECKED AT FIRST ARTICLE INSPECTION.
 5. REMOVE ALL BURRS AND SHARP EDGES.
 6. FINISHED PRODUCT TO BE ROHS COMPLIANT.

SUGGESTION FOR PCB HOLE SIZE:
 1) DRILL SIZE: 3.0mm
 2) ANNUAL RING: 6.0mm

DIMENSIONAL TOLERANCE			
DECIMAL PLACES	MILLIMETERS	INCHES	
.	± 0.50	-	
.X	± 0.30	-	
.XX	± 0.20	-	

UNLESS OTHERWISE SPECIFIED

ANGULAR DIMENSIONS	THIRD ANGLE PROJECTION
± 1.0°	

DRAWN		CHECKED		APPROVED	
SIDNEY		CHRIS		CHRIS	

TITLE					
PLASTIC PUSH-PIN ASSY.					
MATERIAL		SEE NOTES			
FINISH		SEE NOTES			
CUS. PART NO.		CUS. REV.			

JABRO THERMAL

PART NO.	REV.	SHEET	DATE
JSC00151	0	4 OF 6	2023-11-15

3) Screw_M2x3.0

REVISIONS			
REV.	COMMENT	DATE	APPROVED
0	INITIAL RELEASE	2023-11-15	CHRIS

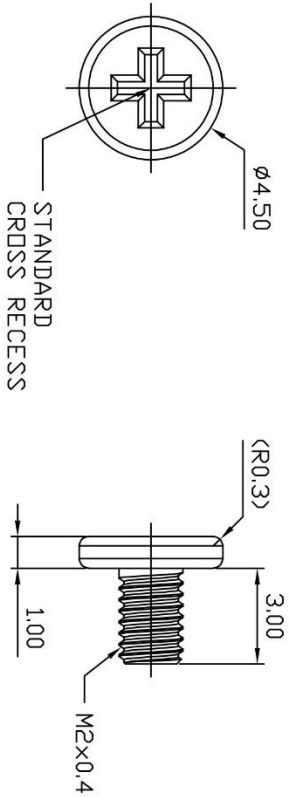

ISOMETRIC VIEW
SCALE 5:1

- NOTES:
1. THIS DRAWING CONTAINS OVERALL DIMENSIONS ONLY. REFER TO 3D CAD DATABASE FOR COMPLETE PART INFORMATION.
 2. PARTS TO BE CLEAN AND FREE OF CRACKS, FOREIGN MATTER, NO OIL OR LUBRICANTS ON THE SURFACE.
 3. ALL DIMENSIONS SHOWN SHALL BE CHECKED AT FIRST ARTICLE INSPECTION.
 4. REMOVE ALL BURRS AND SHARP EDGES.
 5. FINISHED PRODUCT TO BE ROHS COMPLIANT.

DIMENSIONAL TOLERANCE		DRAWN		TITLE	
DECIMAL PLACES	MILLIMETERS	INCHES	SCREW_M2X3.0		
.	± 0.50	-	SAE 1018		
.X	± 0.30	-	NICKEL PLATING		
.XX	± 0.20	-	CUS. PART NO.		
UNLESS OTHERWISE SPECIFIED		CUS. REV.			
ANGULAR DIMENSIONS		THIRD ANGLE PROJECTION			
± 1.0°		APPROVED			
SCALE	5:1	UNIT	mm	SIZE	A4
DRAWN		CHECKED		PART NO.	
SIDNEY		CHRIS		JSC00151	
MATERIAL		FINISH		REV.	
SAE 1018		NICKEL PLATING		0	
TITLE		CUS. PART NO.		SHEET	
SCREW_M2X3.0		NICKEL PLATING		5 OF 6	
DRAWN		APPROVED		DATE	
SIDNEY		CHRIS		2023-11-15	

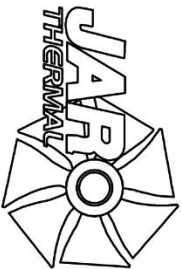

4) Thermal pad

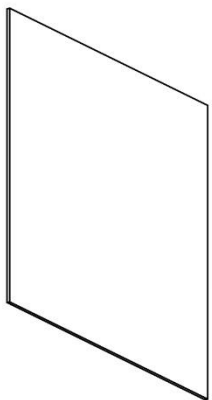
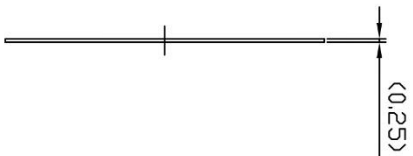
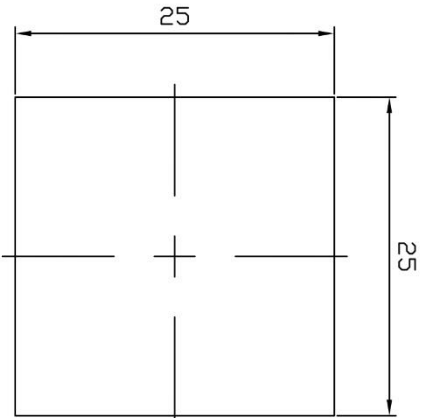

ISOMETRIC VIEW
SCALE 2:1

REVISIONS			
REV.	COMMENT	DATE	APPROVED
0	INITIAL RELEASE	2023-11-15	CHRIS

- NOTES:
1. THIS DRAWING CONTAINS OVERALL DIMENSIONS ONLY. REFER TO 3D CAD DATABASE FOR COMPLETE PART INFORMATION.
 2. PARTS TO BE CLEAN AND FREE OF CRACKS, FOREIGN MATTER, NO OIL OR LUBRICANTS ON THE SURFACE.
 3. ALL DIMENSIONS SHOWN SHALL BE CHECKED AT FIRST ARTICLE INSPECTION.
 4. FINISHED PRODUCT TO BE ROHS COMPLIANT.
 5. DO NOT USE THE PAD IN THE ENVIRONMENT WITH CORROSIVE AIR OR LIQUID. THE PAD MUST BE STORED AT ROOM TEMPERATURE CONDITION 22°C (FAHRENHEIT 71.6°F), AND 50% RH.

DIMENSIONAL TOLERANCE		DRAWN		TITLE	
DECIMAL PLACES	MILLIMETERS	INCHES		MATERIAL	THERMAL PAD
.	± 0.50	-	SIDNEY	LAIRD Tpcm 5810	
X	± 0.30	-	CHECKED	COLOR	GRAY
XX	± 0.20	-		CUS. PART NO.	CUS. REV.
UNLESS OTHERWISE SPECIFIED			CHRIS		
ANGULAR DIMENSIONS		THIRD ANGLE PROJECTION	APPROVED	PART NO.	JSC00151
± 1.0°			CHRIS	REV.	0
SCALE	2:1	UNIT	mm	SHEET	6 OF 6
		SIZE	A4	DATE	2023-11-15

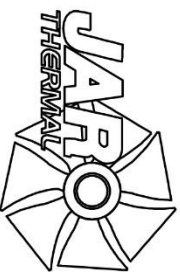



JARO THERMAL

SPECIFICATION FOR APPROVAL

Customer :
Customer Part No. :
Description : DC Fan
JARO Model No. : JEY0501012HB1A01(V24AR)-X(2319) REV.0
Sample Issue No. :
Sample Issue Date :
 Preliminary Specification
 Formal Specification

PREPARED BY :	Franco Huang	DATE :	10/19/2022
CHECKED BY :	Ivan Chen	DATE :	10/19/2022
APPROVED BY :	Jay Su	DATE :	10/19/2022

PLEASE SEND ONE COPY OF THIS SPECIFICATION BACK AFTER YOU SIGNED APPROVAL FOR PRODUCTION PRE-ARRANGEMENT.

By: _____ (printed)

Signature: _____

Date: _____



Jaro Thermal USA office
6600 Park of Commerce Blvd.
Boca Raton, Florida 33487
www.jarothermal.com
Ph: 561-241-6700
Fx: 561-241-3328

Jaro Thermal Taiwan office
Building H, No.119-1, Zhudong Rd., Renwu
Dist., Kaohsiung City, Taiwan 81448
www.jarothermal.com
Ph: +886-7-375-2053
Fx: +886-7-374-7403

We keep the world cool™



JARO SPEC NUMBER	
SPEC	2319

Revision of Spec History

Revision	Change Content	Change page	DATE	BY
0	Created SPEC		10/19/2022	Franco Huang

Notice:

1. This specification will be changed base on Jaro Thermal 's notification. Pls refer to update revision of spec by contacting Jaro Thermal.
2. This specification clarify all the mechanical & electrical characteristics of DC brushless fans & AC brushless fans & Heatsink.
3. The specification of this product is described in detailed document. Pls do not use the fan without proper usage. Pls contact Jaro Thermal if you have special requirement which is not listed on this specification.
4. Any of change, pls contact Jaro Thermal to change the new revision in order to make sure all technical data is up to date. Any ECN change will be followed by sending new update spec.



SPECIFICATION



JARO Model : JEY0501012HB1A01(V24AR)-X(2319)

Samples attached : pcs

Safety Approval : CE

FEATURES

<input type="checkbox"/>	FG SIGNAL	<input type="checkbox"/>	HIGH TEMP RATED	<input type="checkbox"/>	IP-68RATED
<input type="checkbox"/>	RD SIGNAL	<input type="checkbox"/>	SINGLE PHASE	<input type="checkbox"/>	4-POLE
<input type="checkbox"/>	PWM	<input type="checkbox"/>	THREE PHASE	<input type="checkbox"/>	8-POLE

DIMENSIONS : 50 X 50 X 10 mm

BEARING TYPE : TWO BALL BEARINGS

MOTOR PROTECTION : BY IC

RATED VOLTAGE : 12 VDC

OPERATING VOLTAGE RANGE : 7.0 ~ 13.2 VDC

START-UP VOLTAGE : 7.0 VDC , POWER ON/OFF

REAL CURRENT : 0.10 Amp

REAL POWER : 1.20 Watt

RATED CURRENT : 0.25 Amp +10% MAX

RATED POWER : 3.00 Watt

RATED SPEED : 5000 RPM ± 10 %
(IN FREE AIR AT RATED VOLTAGE)

AIR FLOW : 10.65 CFM (min.: 9.585 CFM)

AIR FLOW : 0.301 CMM (min.: 0.270 CMM)
(IN FREE AIR AT RATED VOLTAGE)

STATIC AIR PRESSURE : 0.090 InH₂O (min.: 0.072 InH₂O)

STATIC AIR PRESSURE : 2.31 mmH₂O (min.: 1.871 mmH₂O)
(IN FREE AIR AT RATED VOLTAGE)

NOISE LEVEL : 29.0 dB(A) (MAX.: 33.0 dB(A))

LIFE EXPECTANCY : 70000 Hours at 40°C / 65% RH

NET WEIGHT : 11 Gram



The standard of Jaro Thermal's fan relative humidity is 65%, and the temperature is 25°C for the standard testing. If you have any question, pls refer to environmental condition on 5-0 first. Other special request pls contact Jaro Thermal for spec checking.



SPECIFICATION

JARO MODEL: JEY0501012HB1A01(V24AR)-X(2319)

1-0 MATERIAL

- 1-1 Frame Material - PBT OF UL 94 V-0
- 1-2 Fan Blade Material – PBT OF UL 94 V-0
- 1-3 Other material – See 8.0 Dimension Drawing
- 1-4 Environmental Standard
 - [V] RoHS
 - [V] REACH
 - [] Halogen Free

2-0 FAN VOLTAGE CURRENT, LOCK ROTOR, AIR FLOW, STATIC PRESSURE & NOISE DEFINITION

- 2-1 Start Voltage - By sudden switching ON fan is start to rotate.
- 2-2 Input Power - Input Power shall be measured after 3 minutes for continuing rotation by rated voltage.
- 2-3 Rated Current - Rated Current shall be measured after 3 minutes by continuing rotation by rated voltage.
- 2-4 Rated Speed - Rated Speed shall be measured after 3 minutes for continuing rotation by rated voltage.
- 2-5 Locked Rotor Current : Locked current shall be measured within one minute of rotor locked, after 3 minutes by continuing rotation at rated voltage in clean air.
- 2-6 Air Flow & Static Pressure : The air flow data and static pressures should be determined in accordance with AMCA-210 standard or DIN24163 specification in chamber testing and record the test record.
- 2-7 Noise Level : The measurement of noise level is carried out with reference to CNS8753 in an anechoic chamber with the microphone positioned 1 meter from the air intake. Testing fan shall be hung in clean air .

Noise Level Measure

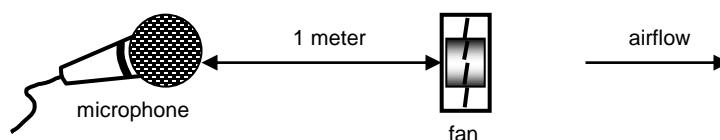



SPECIFICATION

JARO MODEL: JEY0501012HB1A01(V24AR)-X(2319)

3-0 FAN FUNCTION DEFINITION

- 3-1 Rotation Direction - Counterclockwise from impeller side.
- 3-2 Lock Rotor Condition
No damage for winding or electronic in locked rotor condition. And no damage after 72hrs continuing for lock rotor condition.
- 3-3 Auto Restart
Fan will automatic restart without any abnormal usage.
- 3-4 Dead Angle
Switch the fan change from off to on condition. Restart the fan, it will automatic restart by fan power on.
- 3-5 Polarity
Check the voltage and polarity before turn on the power to the fan.
- 3-6 Insulation Resistance
Do not use < 10M ohm between housing and positive end of lead wire (red) at 500V DC.
- 3-7 Dielectric Strength
No damage should be found at 500 VAC for 60 seconds, measured with 1mA trip current between housing and positive end of lead wire.

4-0 FAN PACKAGE TEST

- 4-1 Free Drop Shock
Base on Jaro Thermal's standard package, the fan package will test and drops on any three faces - Test standard is 30cm height. The base is wood board for 10mm thick.

5-0 FAN ENVIRONMENTAL CONDITION

- 5-1 Operating Temperature / Humidity
-10°C to +70°C at humidity 5% to 90% Relative humidity.
- 5-2 Humidity
After 96 hours, 95% RH, 40+/-2°C per MIL-STD-202F, method 103B humidity test, the measured data on insulation resistance and dielectric strength shall meet the specification.
- 5-3 Storage Temperature
All function shall be normal after 500 hours storage at -40°C to +70 °C with a 24 hour recovery period at room temperature. Humidity 5% to 95% Relative humidity
- 5-4 Do not store this fan in an environment with high humidity. This fan must be stored in accordance with the storage temperature. Do not store the fan for over 6 months; If this fan is stored for more than 6 months, JARO THERMAL recommends functional testing before using.



SPECIFICATION

JARO MODEL: JEY0501012HB1A01(V24AR)-X(2319)

5-5 Improper way to disassembled fan will cause the fan get into dust or dip into water. Which will in defects is not covered in the warranty. Do not use the fan in the environment with corrosive air or liquid.

6-0 MASS PRODUCTION SAMPLE PLAN INSPECTION

All fans shall meet the quality inspection under MIL-STD-105E standard list as follow:

Critical 0.25%

Major 1.00%

Minor 2.50%

7-0 FAN USE WITH CAUTION

7-1 Please do not stick a grease and/or an oil to the fan housing or blade which may have a harmful influence by a chemical reaction at high humidity.

7-2 If the fan is reinstalled, please pay special attention to the noise due to the vibration (or resonance).

7-3 During the testing of the fan, please make sure the finger guard is use for your safety.

7-4 While the fan is running, please do not lock the fan intentionally for a long time. This will cause overheating by long period locking status. This action will damage the fan.

7-5 Please do not touch and push Fan Blade with fingers or others, fan blade and ball bearings may be damaged and it causes noise defect.

7-6 Do not carry the fan by its lead wires.

7-7 If the fan does not have the polarity protection function, the connection of the colored wires should be red + red, and black + black, or else the fan will be damaged in no time.

7-8 For the models without reverse connection of polarity protection, please do not connect the lead wire in reverse position.

7-9 Please don't install this fan in series with 2x voltage inputs. For example, if a single fan rated at 12V, then don't install two of them in series with 24V input.

7-10 Every specific fan is designed for its certain application (project). Therefore, if you want to use this fan in other application (project), please inform JARO first so that we can confirm whether there is any issue which might be incurred from the reason of this different application (project) or not.

7-11 The "Life Expectancy" of this fan has not been evaluated for use in combination with any end application. Therefore, the Life Expectancy in the Test Reports(L10 and MTTF Report) that relate to this fan is for reference only and shall not construe any kind of warranty of JARO to the life of any specific fan , either expressed or implied.

7-12 The period of product warranty , unless otherwise agreed by JARO in written , shall be 12 months staring from the date of production.



DIMENSION DRAWING

JARO MODEL: JEY0501012HB1A01(V24AR)-X(2319)

8-0 DIMENSIONS

All dimensions, Direction of rotation and air flow were specified as per drawing attached.

Description: DC Fan with:

Lead Wire: UL1571 AWG#28 , 136 ± 10 mm lead length.

Housing: MOLEX 51021-0400

Terminal: MOLEX 50058-8001

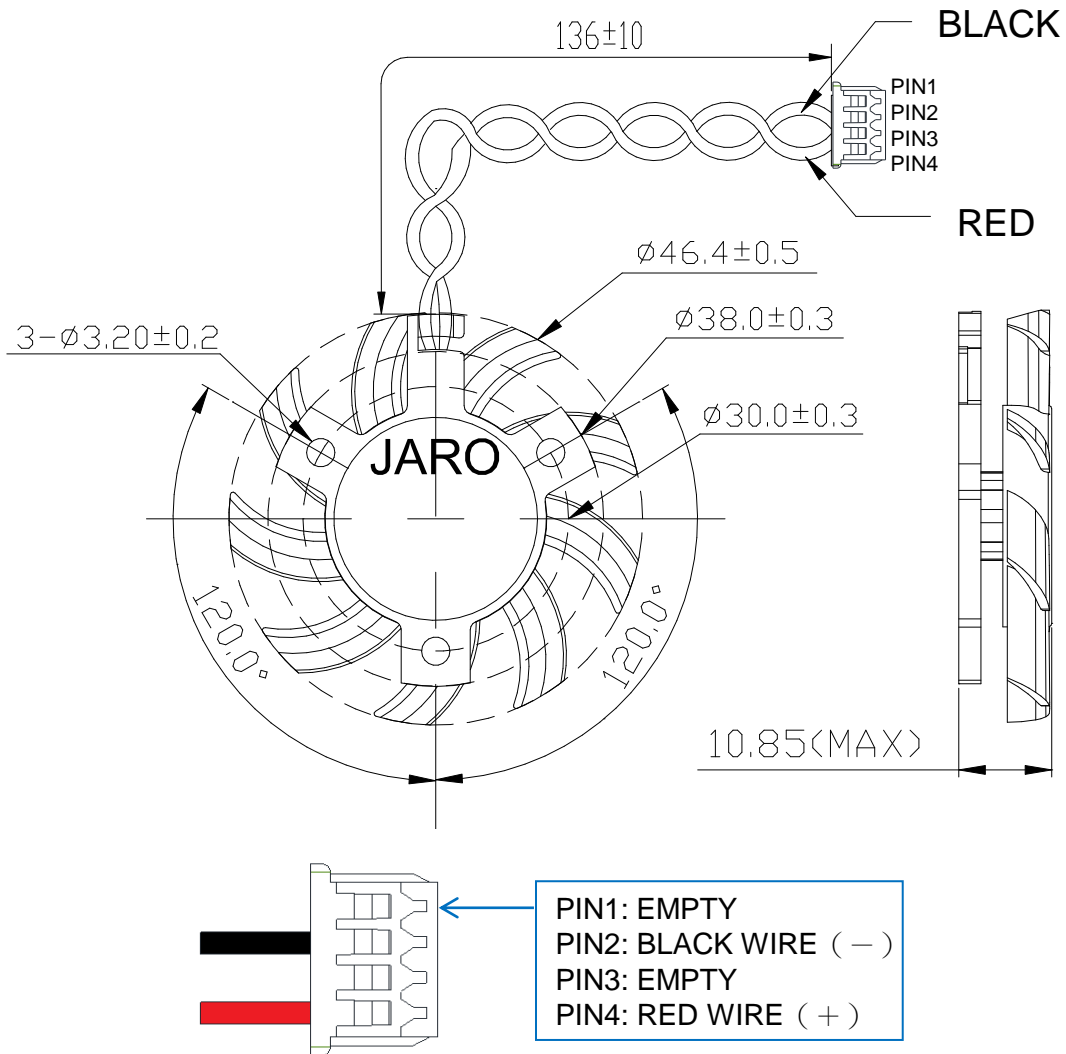

**DIAGRAM OF DIMENSIONS: Dimensions in millimeters
NOT TO SCALE. ALL COMPONENTS MUST BE RoHS/REACH COMPLIANT.**

Drawing Note: N/A

Safety : CE



JARO LABEL DRAWING

JARO MODEL: JEY0501012HB1A01(V24AR)-X(2319)

Label Drawing

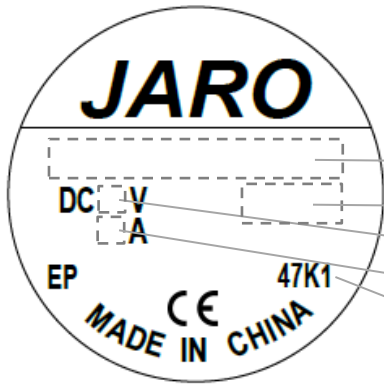

MODEL: **JEY0501012HB1A01**

MODEL: **(V24AR)-X(2319)**

RATED VOLTAGE: **12**

RATED CURRENT: **0.25**

DATECODE: **47K1** (example)

Label Material	Background color
PET	Silver



PERFORMANCE CURVE

JARO MODEL: JEY0501012HB1A01(V24AR)-X(2319)

9-0 PERFORMANCE CURVE

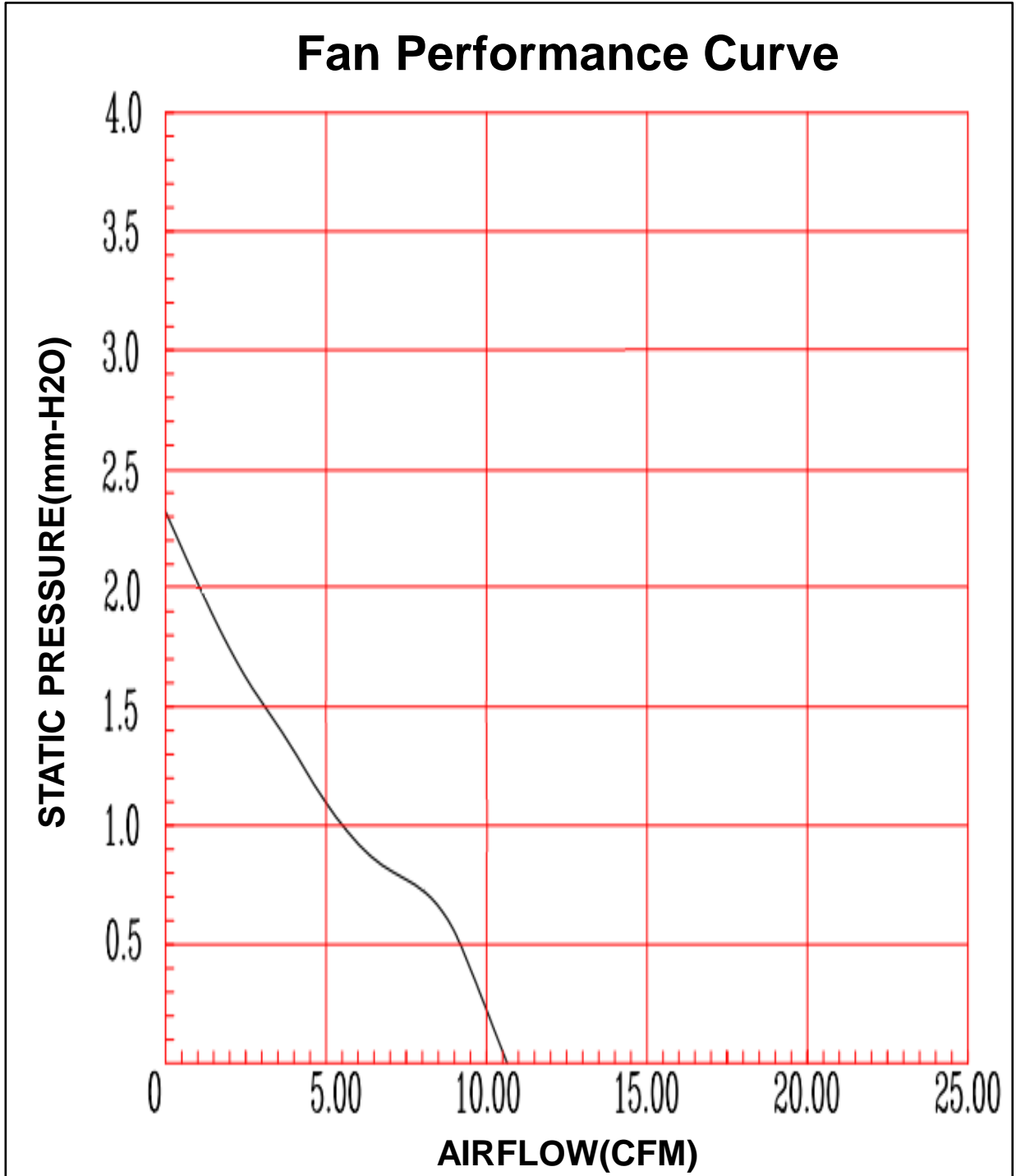



LIFE EXPECTANCY

JARO MODEL: JEY0501012HB1A01(V24AR)-X(2319)

10-0 LIFE EXPECTANCY

故障定義 Product Specification & Failure Definiton	試驗結果：包含故障時間、數據、統計、...等 Test Result : Including Time Of Failure、Datum、Statistics、... ect.																																														
1.風扇不轉 (Fan Not Work) 2.轉速超出規格30% (Speed Over 30% Origin) 3.電流超出規格30% (Current Over 30% Origin)	$\text{TEMP A.F} = e^{(\Delta H / K) \times (\frac{1}{273+Tl} - \frac{1}{273+Th})}$ <ul style="list-style-type: none"> • 溫度加速因子 TEMP A.F = • 總試驗時間 Total Test Time = 200000 HRS. 																																														
Description : 1.性能測試時點 The Time Of Check Point Start : 0Hr, 500Hrs, 1000Hrs And Finished $70^{\circ}\text{C MTTF} = \frac{\text{Total test time (T)}}{\text{Total failure (r)}}$ <p>GEM TABLE 2. Generalized Exponential Model (for Time-Terminated Test)</p> <table border="1" data-bbox="97 886 465 984"> <tr> <td>r</td> <td>0</td> <td>1</td> <td>2</td> <td>3</td> <td>4</td> <td>5</td> </tr> <tr> <td>M</td> <td>2.3026</td> <td>3.8897</td> <td>5.3223</td> <td>6.6808</td> <td>7.99384</td> <td>9.2747</td> </tr> <tr> <td>r</td> <td>6</td> <td>7</td> <td>8</td> <td>9</td> <td>10</td> <td></td> </tr> <tr> <td>M</td> <td>10.5321</td> <td>11.7709</td> <td>12.9947</td> <td>14.2060</td> <td>15.4066</td> <td></td> </tr> </table>	r	0	1	2	3	4	5	M	2.3026	3.8897	5.3223	6.6808	7.99384	9.2747	r	6	7	8	9	10		M	10.5321	11.7709	12.9947	14.2060	15.4066		<ul style="list-style-type: none"> • 查表得 (MTTF By GEM Table) MTTF = 86858 HRS. • 溫度 / TEMP. / MTTF / L10 <table border="1" data-bbox="678 752 1260 990"> <thead> <tr> <th>溫度TE MP.</th> <th>信賴水準90% CONFIDENCE LEVEL</th> <th>L10</th> </tr> </thead> <tbody> <tr> <td>30 °C</td> <td>1559455</td> <td>164153</td> </tr> <tr> <td>40 °C</td> <td>706937</td> <td>74414</td> </tr> <tr> <td>50 °C</td> <td>336561</td> <td>35427</td> </tr> <tr> <td>60 °C</td> <td>167535</td> <td>17635</td> </tr> <tr> <td>70 °C</td> <td>86858</td> <td>9143</td> </tr> </tbody> </table>	溫度TE MP.	信賴水準90% CONFIDENCE LEVEL	L10	30 °C	1559455	164153	40 °C	706937	74414	50 °C	336561	35427	60 °C	167535	17635	70 °C	86858	9143
r	0	1	2	3	4	5																																									
M	2.3026	3.8897	5.3223	6.6808	7.99384	9.2747																																									
r	6	7	8	9	10																																										
M	10.5321	11.7709	12.9947	14.2060	15.4066																																										
溫度TE MP.	信賴水準90% CONFIDENCE LEVEL	L10																																													
30 °C	1559455	164153																																													
40 °C	706937	74414																																													
50 °C	336561	35427																																													
60 °C	167535	17635																																													
70 °C	86858	9143																																													
3. Herewith, we could assume as right on the basis of above test result. Besides, if the actual test time exceed the required, it comes out that those fans' L ₁₀ expectancy and MTTF are greater than the warrant. MTTF: Mean Time To Failures. It should be used in a non-requirable system setting. Now we show the MTTF in our life report, that's because we will not repair the failed fans during life experiment. MTBF: Mean Time Between Failures. It should be used in a repairable system setting. Basically, MTBF is equal to MTTF, they use same formula to work out a life data.																																															

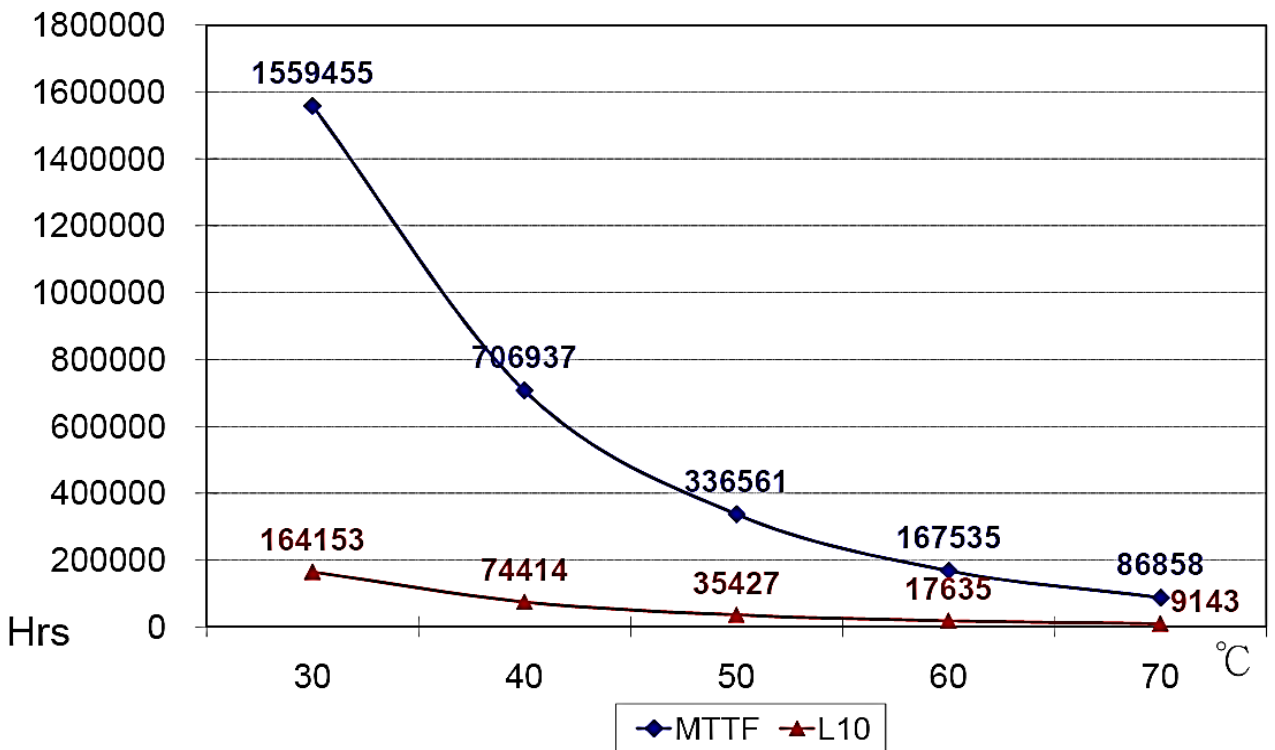

JARO MODEL: JEY0501012HB1A01(V24AR)-X(2319)

NOTICE FOR OPERATION

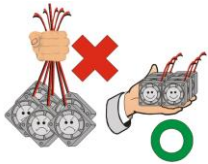

1



2

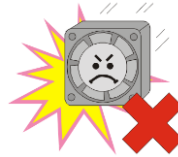

3



4

1. Hold the fan by frame side.
Do not hold lead wires.(Fig.1)
2. Do not touch or press on the impeller.
Do not crush the frame. (Fig.2)
3. Do not drop the fan on the ground.
Hit the frame may cause the fan damaged. (Fig.3)
4. Connect the power cord properly and apply voltage according to specification. (Fig.4)

NOTICE FOR ASSEMBLY AND AMBIENT CONDITIONS

1. When applying our fan your device, please check thoroughly any variation of EMC, temperature rise, life data, quality, etc. of this product by shock/drop/vibration testing, etc. If there is any problem or accident in connection with this product, it should be mutually discussed and checked by both parties.
2. Take proper care for handling this fan. Components such as fan holders or bearings may be damaged by fingers touch or other objects. Additionally, static electricity (ESD) may damage the internal circuits of the fan.
3. DO NOT operate this fan in proximity to hazardous materials such as organic silicon, cyanogen, formalin, phenol, or corrosive gas environments. Any hazardous materials flow to the fan side may cause damaged or malfunction.
4. JARO recommends that you protect this fan from exposure to outside elements such as dust, condensation, humidity or insects.
Exposure of this fan to outside elements such as dust, condensation, humidity or insects may affect its performance and may cause safety hazards. JARO does not guarantee the damage to the product caused by outside elements.
5. This fan must be installed properly and securely. Improper mounting may cause harsh resonance, vibration, and noise. If you have any question about fan mounting, please discuss with JARO if you are not sure the correct mounting method.
6. DO NOT use or store the fan with higher humidity and temperature specified in spec.
The fan must be stored with the attached specifications regarding storage temperature. If this fan is stored for more than 6 months, JARO recommends to perform functional testing before using. Please contact JARO if you are not sure how to perform functional test.
7. The "Life Expectancy" of this fan has not been evaluated for use in combination with any end application. Therefore, the Life Expectancy Test Reports (L10 and MTTF Report) that relate to this fan are only for reference.
8. Fan guards may prevent injury during handling or installation of the fan.