

# DC CENTRIFUGAL FAN



**Φ220x76mm**

- MOTOR : DC single phase brushless motor
- FRAME : Aluminum ; IMPELLER : Plastic(UL 94V-0)
- OPERATING TEMP.: -10°C~70°C
- STORAGE TEMP.: -40°C~75°C
- WEIGHT : 1450g



JARO Part Number	Bearing System	Rated Voltage V	Rated Current A	Rated Speed RPM	Maximum Air Flow		Maximum Static Pressure		Sound Level dBA
					m <sup>3</sup> /h	CFM	mm-H <sub>2</sub> O	In-H <sub>2</sub> O	
JSD2207624HBBA02	BALL	24	5.0	3100	1112.1	653.9	60.5	2.38	72
JSD2207648HBBA02	BALL	48	3.3	3100	1112.1	653.9	60.5	2.38	72

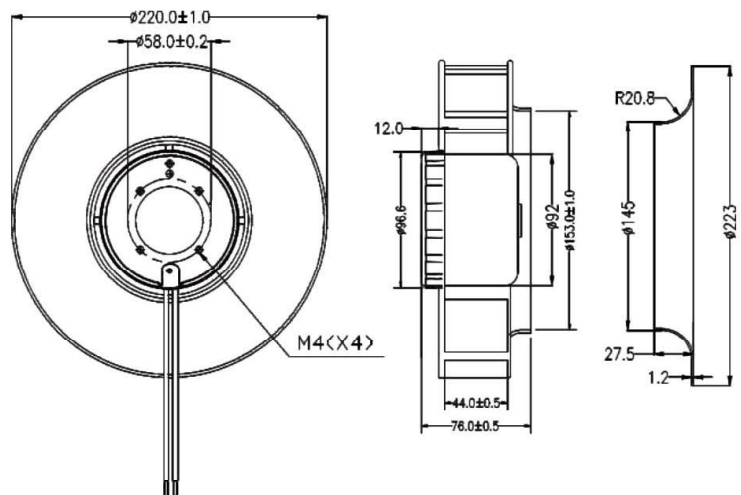
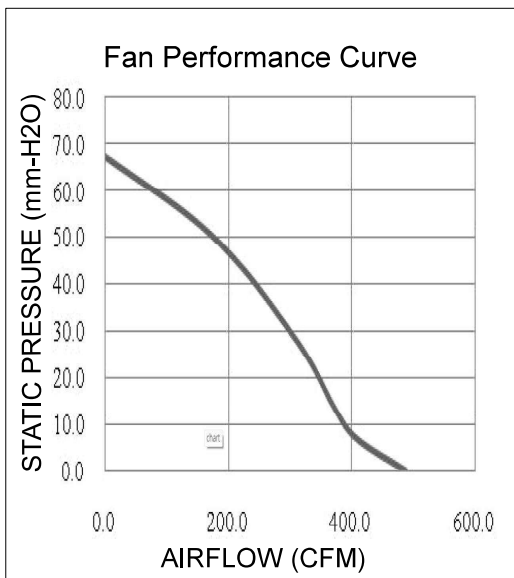

\*All models can be customized. Please contact your JARO representative for further information.

\*Specs are subject to change without notice. Please visit JARO website at <https://jarothermal.com> for update information.