

REVISIONS			
REV.	COMMENT	DATE	APPROVED
0	INITIAL RELEASE	2023-09-07	CHRIS

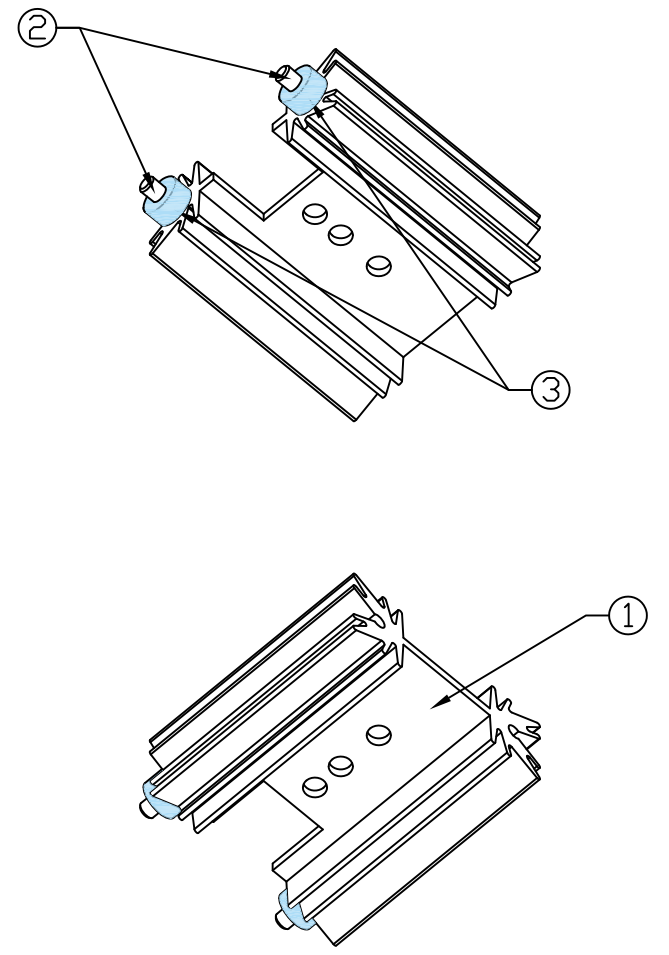

ISOMETRIC VIEW  
SCALE 1:1

- NOTES:
- THIS DRAWING CONTAINS OVERALL DIMENSIONS ONLY. REFER TO 3D CAD DATABASE FOR COMPLETE PART INFORMATION.
  - PARTS TO BE CLEAN AND FREE OF CRACKS, FOREIGN MATTER, NO OIL OR LUBRICANTS ON THE SURFACE.
  - ALL DIMENSIONS SHOWN SHALL BE CHECKED AT FIRST ARTICLE INSPECTION.
  - REMOVE ALL BURRS AND SHARP EDGES.
  - FINISHED PRODUCT TO BE RoHS COMPLIANT.
  - TOLERANCE:  $\pm 0.30\text{mm}$

ITEM	QTY.	DESCRIPTION	MATERIAL	REMARK
3	2	WASHER	NYLON66 (UL94-V2)	COLOR: BLACK
2	2	PIN	CRS	FINISH: TIN PLATED
1	1	HEAT SINK	AL 6063-T5	FINISH: BLACK ANODIZE

DIMENSIONAL TOLERANCE		
DECIMAL PLACES	MILLIMETERS	INCHES
	-	-
.X	-	-
.XX	-	-
UNLESS OTHERWISE SPECIFIED		
ANGULAR DIMENSIONS	THIRD ANGLE PROJECTION	
$\pm 1.0^\circ$		
SCALE	UNIT	SIZE
1:1	mm	A3

DRAWN	TITLE	
SIDNEY	EXTRUDED PC MOUNT HEAT SINK	
CHECKED	MATERIAL	
CHRIS	SEE TABLE	
APPROVED	FINISH	
CHRIS	SEE TABLE	
	CUS. PART NO.	CUS. REV.
	PART NO.	REV.
	JBHAE2082	0

SHEET		DATE	
1 OF 1		2023-09-07	

