

1

2

3

4

5

6

REVISIONS

REV.	COMMENT	DATE	APPROVED
0	INITIAL RELEASE	2023-09-12	CHRIS

D

D

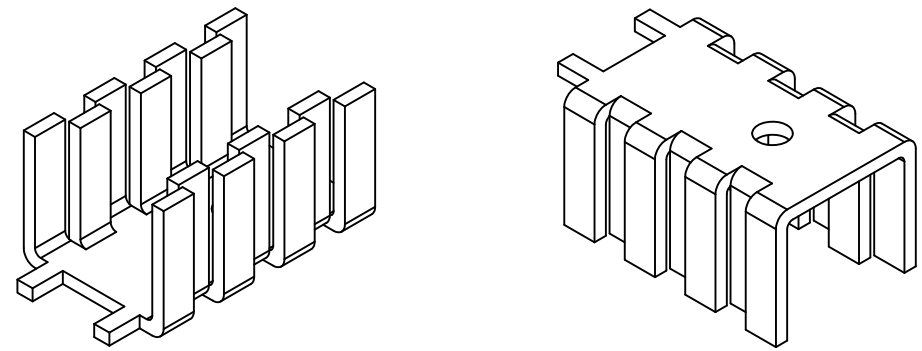
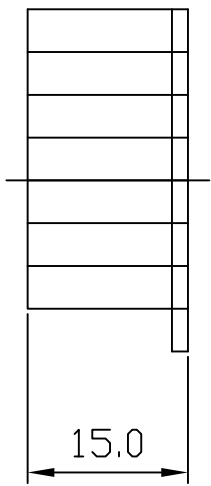
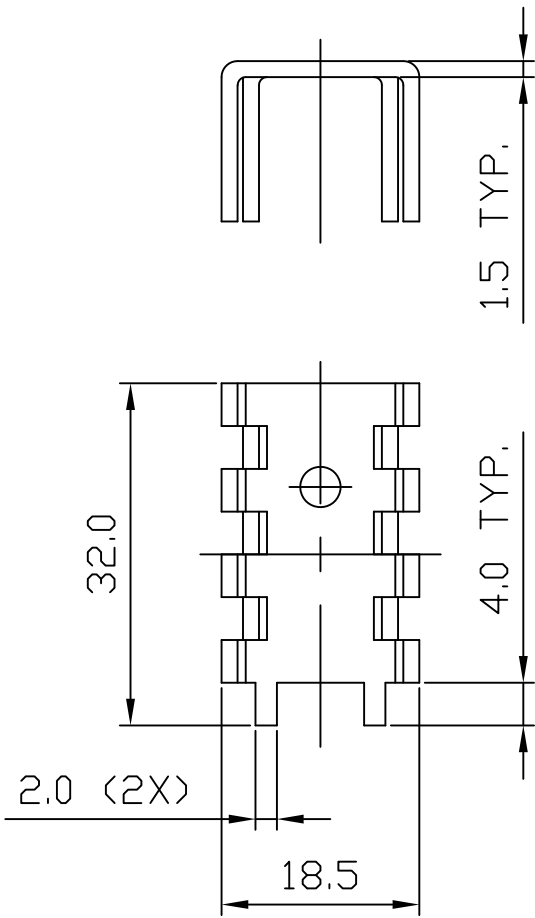

ISOMETRIC VIEW  
SCALE 1:1

C

C

B

B

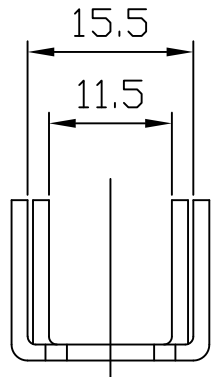



NOTES:

- THIS DRAWING CONTAINS OVERALL DIMENSIONS ONLY. REFER TO 3D CAD DATABASE FOR COMPLETE PART INFORMATION.
- PARTS TO BE CLEAN AND FREE OF CRACKS, FOREIGN MATTER. NO OIL OR LUBRICANTS ON THE SURFACE.
- ALL DIMENSIONS SHOWN SHALL BE CHECKED AT FIRST ARTICLE INSPECTION.
- REMOVE ALL BURRS AND SHARP EDGES.
- FINISHED PRODUCT TO BE RoHS COMPLIANT.
- TOLERANCE: ±0.50mm

A

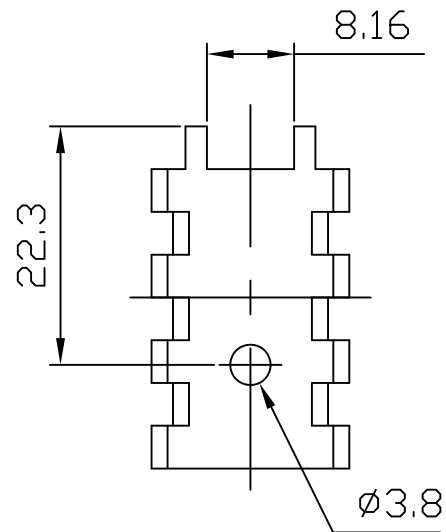
A

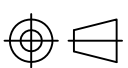

DIMENSIONAL TOLERANCE			DRAWN	TITLE				
DECIMAL PLACES	MILLIMETERS	INCHES						
.	-	-	SIDNEY	STAMPED HEAT SINK				
.X	-	-		MATERIAL AL 1050				
.XX	-	-	CHECKED	FINISH BLACK ANODIZE				
UNLESS OTHERWISE SPECIFIED			CHRIS	CUS. PART NO.		CUS. REV.		
ANGULAR DIMENSIONS ± 1.0°		THIRD ANGLE PROJECTION 		APPROVED		PART NO. JBHAS0081		REV. 0
SCALE 1:1	UNIT mm	SIZE A4	CHRIS	SHEET 1 OF 1		DATE 2023-09-12		

1

2

3

4

5

6