



# JARO THERMAL

## SPECIFICATION FOR APPROVAL

Customer :  
Customer Part No. :  
Description : Thermal module  
JARO Model No. : JSC00132 REV.0  
Sample Issue No. :  
Sample Issue Date :  
 Preliminary Specification  
 Formal Specification

PREPARED BY :	Sidney Li	DATE :	09/27/2022
CHECKED BY :	Chris Hsu	DATE :	09/27/2022
APPROVED BY :	Chris Hsu	DATE :	09/27/2022

**PLEASE SEND ONE COPY OF THIS SPECIFICATION BACK AFTER YOU SIGNED APPROVAL FOR PRODUCTION PRE-ARRANGEMENT.**

By: \_\_\_\_\_ (printed)

Signature: \_\_\_\_\_

Date: \_\_\_\_\_



Jaro Thermal USA office  
6600 Park of Commerce Blvd.  
Boca Raton, Florida 33487  
[www.jarothermal.com](http://www.jarothermal.com)  
Ph: 561-241-6700  
Fx: 561-241-3328

Jaro Thermal Taiwan office  
Building H, No.119-1, Zhudong Rd., Renwu  
Dist., Kaohsiung City, Taiwan 81448  
[www.jarothermal.com](http://www.jarothermal.com)  
Ph: +886-7-375-2053  
Fx: +886-7-374-7403

**We keep the world cool™**



**JARO MODEL NUMBER**

**JSC00132**



### Revision of Spec History

Revision	Change Content	Change page	DATE	BY
0	Created SPEC		09/27/2022	Sidney Li

#### Notice:

1. This specification will be changed base on Jaro Thermal 's notification. Please refer to update revision of spec by contacting Jaro Thermal.
2. This specification clarify all the mechanical & electrical characteristics of DC brushless fans & AC brushless fans & heat sink.
3. The specification of this product is described in detailed document. Please do not use the fan without proper usage. Please contact Jaro Thermal if you have special requirement which is not listed on this specification.
4. Any of change, please contact Jaro Thermal to change the new revision in order to make sure all technical data is up to date. Any ECN change will be followed by sending new update specification.

# 1. Assembly drawing

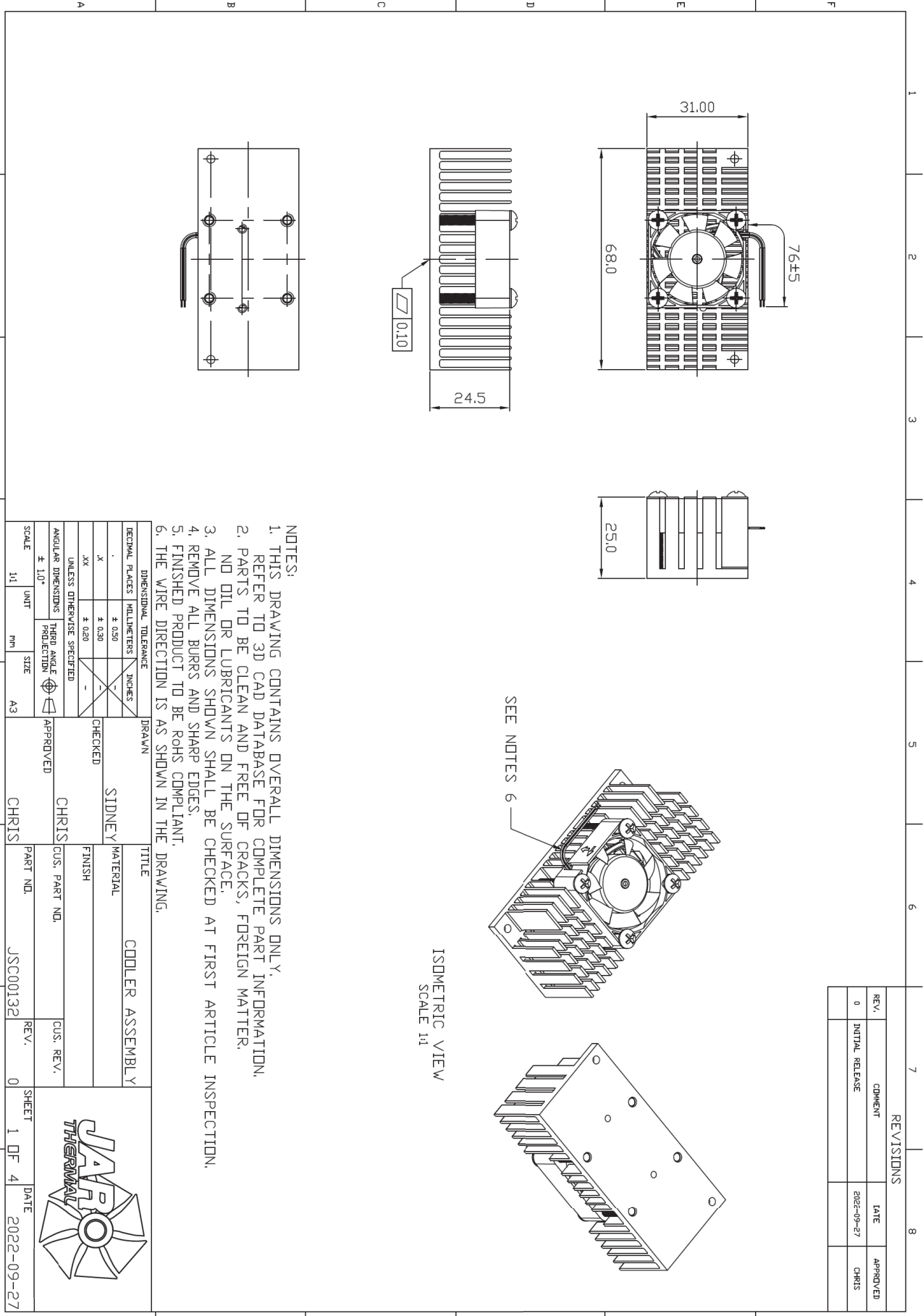

REVISIONS		
REV.	COMMENT	DATE
0	INITIAL RELEASE	2022-09-27
		CHRIS

## 2. Exploded views

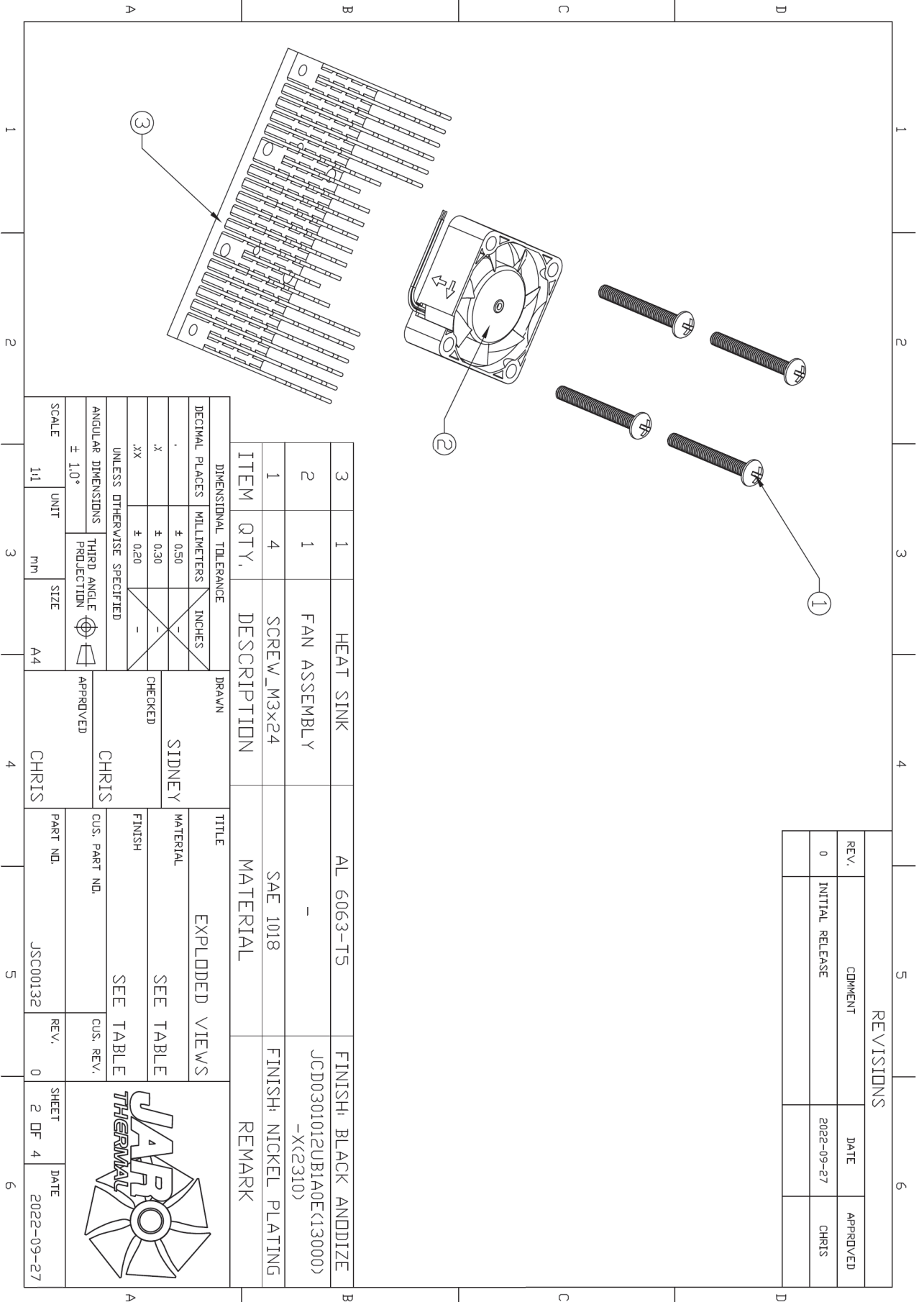

REVISIONS			
REV.	COMMENT	DATE	APPROVED
0	INITIAL RELEASE	2022-09-27	CHRIS

ITEM	QTY.	DESCRIPTION	MATERIAL	REMARK
3	1	HEAT SINK	AL 6063-T5	FINISH: BLACK ANODIZE
2	1	FAN ASSEMBLY	-	JCD0301012UBIAD0E(13000) -X(2310)
1	4	SCREW_M3x24	SAE 1018	FINISH: NICKEL PLATING

DIMENSIONAL TOLERANCE		DRAWN		TITLE	
DECIMAL PLACES	MILLIMETERS	SIDNEY		EXPLODED VIEWS	
.	± 0.50	CHECKED		MATERIAL	
.X	± 0.30	CHRIS		SEE TABLE	
.XX	± 0.20	APPROVED		FINISH	
UNLESS OTHERWISE SPECIFIED		CHRIS		SEE TABLE	
ANGULAR DIMENSIONS		THIRD ANGLE PROJECTION		CUS. PART NO.	
± 1.0°		A4		CUS. REV.	
SCALE	UNIT	SIZE	PART NO.	REV.	SHEET
1:1	mm	A4	JSC00132	0	2 OF 4
					DATE
					2022-09-27

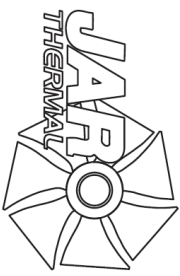

# 3. Individual component drawing

## 1) Heat sink

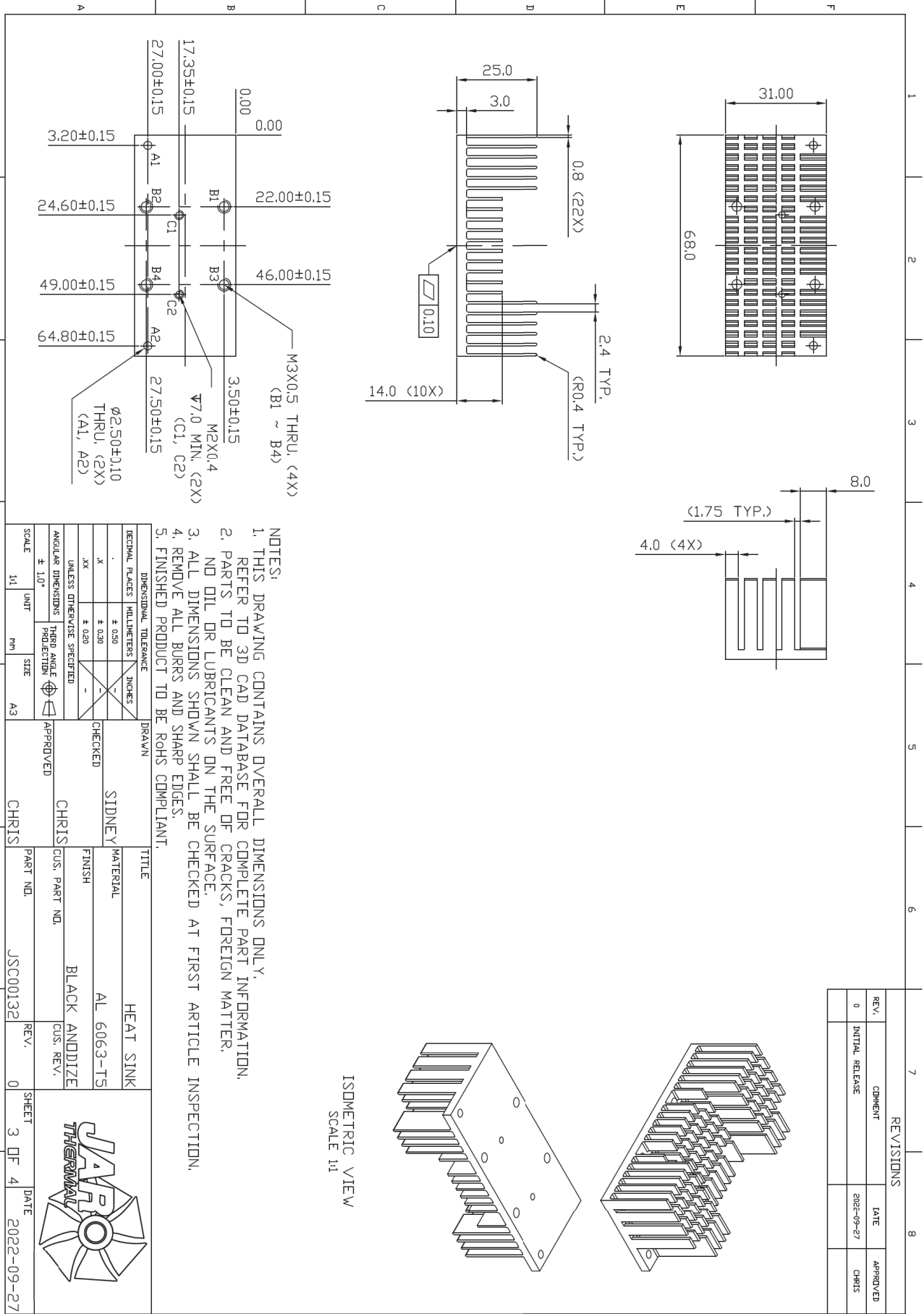

# 2) Screw\_M3x24

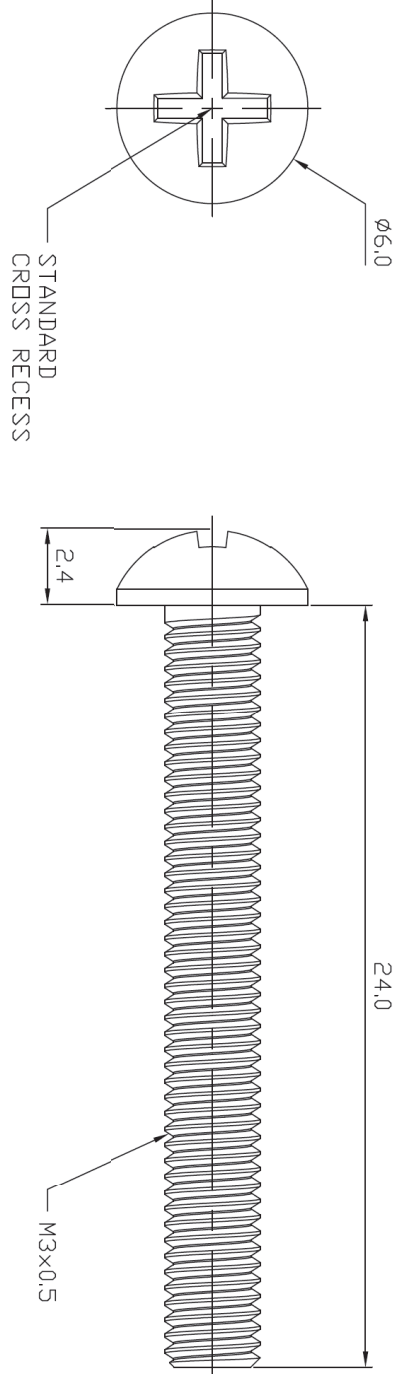

ISOMETRIC VIEW  
SCALE 2:1

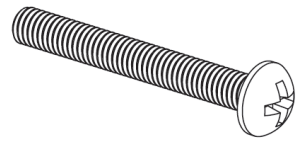

- NOTES:
1. THIS DRAWING CONTAINS OVERALL DIMENSIONS ONLY, REFER TO 3D CAD DATABASE FOR COMPLETE PART INFORMATION.
  2. PARTS TO BE CLEAN AND FREE OF CRACKS, FOREIGN MATTER, NO OIL OR LUBRICANTS ON THE SURFACE.
  3. ALL DIMENSIONS SHOWN SHALL BE CHECKED AT FIRST ARTICLE INSPECTION.
  4. REMOVE ALL BURRS AND SHARP EDGES.
  5. FINISHED PRODUCT TO BE ROHS COMPLIANT.

DIMENSIONAL TOLERANCE		DRAWN		TITLE	
DECIMAL PLACES	MILLIMETERS	INCHES	CHECKED	MATERIAL	SCREW_M3x24
.	$\pm 0.50$	-	SIDNEY	SAE 1018	
.X	$\pm 0.30$	-	CHRIS	NICKEL PLATING	
.XX	$\pm 0.20$	-			
UNLESS OTHERWISE SPECIFIED					
ANGULAR DIMENSIONS		THIRD ANGLE PROJECTION	APPROVED	CUS. PART NO.	
$\pm 1.0^\circ$			CHRIS	CUS. REV.	
SCALE	S:1	UNIT	mm	PART NO.	JSC00132
		SIZE	A4	REV.	0

REVISIONS		
REV.	COMMENT	DATE
0	INITIAL RELEASE	2022-09-27
		CHRIS

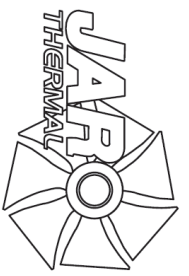



# JARO THERMAL

## SPECIFICATION FOR APPROVAL

Customer :  
Customer Part No. :  
Description : DC FAN  
JARO Model No. : JCD0301012UB1A0E(13000)-X(2310) REV.0  
Sample Issue No. :  
Sample Issue Date :  
 Preliminary Specification  
 Formal Specification

PREPARED BY :	Franco Huang	DATE :	09/26/2022
CHECKED BY :	Ivan Chen	DATE :	09/26/2022
APPROVED BY :	Jay Su	DATE :	09/26/2022

**PLEASE SEND ONE COPY OF THIS SPECIFICATION BACK AFTER YOU SIGNED APPROVAL FOR PRODUCTION PRE-ARRANGEMENT.**

By: \_\_\_\_\_ (printed)

Signature: \_\_\_\_\_

Date: \_\_\_\_\_



Jaro Thermal USA office  
6600 Park of Commerce Blvd.  
Boca Raton, Florida 33487  
[www.jarothermal.com](http://www.jarothermal.com)  
Ph: 561-241-6700  
Fx: 561-241-3328

Jaro Thermal Taiwan office  
Building H, No.119-1, Zhudong Rd., Renwu  
Dist., Kaohsiung City, Taiwan 81448  
[www.jarothermal.com](http://www.jarothermal.com)  
Ph: +886-7-375-2053  
Fx: +886-7-374-7403

**We keep the world cool™**



<b>JARO SPEC NUMBER</b>	
<b>SPEC</b>	<b>2310</b>

### Revision of Spec History

Revision	Change Content	Change page	DATE	BY
0	Created SPEC		09/26/2022	Franco Huang

#### Notice:

1. This specification will be changed base on Jaro Thermal 's notification. Pls refer to update revision of spec by contacting Jaro Thermal.
2. This specification clarify all the mechanical & electrical characteristics of DC brushless fans & AC brushless fans & Heatsink.
3. The specification of this product is described in detailed document. Pls do not use the fan without proper usage. Pls contact Jaro Thermal if you have special requirement which is not listed on this specification.
4. Any of change, pls contact Jaro Thermal to change the new revision in order to make sure all technical data is up to date. Any ECN change will be followed by sending new update spec.





# SPECIFICATION



<b>Jaro Model</b>	: JCD0301012UB1A0E(13000)-X(2310)
<b>Samples attached</b>	: pcs
<b>Safety Approval</b>	: UL/CUL/CE
<b>FEATURES</b>	<input type="checkbox"/> FG SIGNAL <input type="checkbox"/> HIGH TEMP RATED <input type="checkbox"/> IP-55 RATED <input type="checkbox"/> RD SIGNAL <input checked="" type="checkbox"/> SINGLE PHASE <input checked="" type="checkbox"/> 4-POLE <input type="checkbox"/> PWM <input type="checkbox"/> THREE PHASE <input type="checkbox"/> 8-POLE
<b>DIMENSIONS</b>	: 30 X 30 X 10 mm
<b>BEARING TYPE</b>	: TWO BALL BEARINGS
<b>MOTOR PROTECTION</b>	: BY IC
<b>RATED VOLTAGE</b>	: 12.0 VDC
<b>OPERATING VOLTAGE RANGE</b>	: 6.0 ~ 13.2 VDC
<b>START-UP VOLTAGE</b>	: 6.0 VDC , ( POWER ON/OFF)
<b>REAL CURRENT</b>	: 0.14 Amp
<b>REAL POWER</b>	: 1.68 Watt
<b>RATED CURRENT</b>	: 0.17 Amp (MAX:0.33Amp)
<b>RATED POWER</b>	: 2.04 Watt
<b>RATED SPEED</b>	: 13000 RPM ± 20 % (IN FREE AIR AT RATED VOLTAGE)
<b>AIR FLOW</b>	: 6.33 CFM (min.: 5.064 CFM)
<b>AIR FLOW</b>	: 0.179 CMM (min.: 0.143 CMM) (IN FREE AIR AT RATED VOLTAGE)
<b>STATIC AIR PRESSURE</b>	: 0.421 InH <sub>2</sub> O (min.: 0.269 InH <sub>2</sub> O)
<b>STATIC AIR PRESSURE</b>	: 10.71 mmH <sub>2</sub> O (min.: 6.854 mmH <sub>2</sub> O) (IN FREE AIR AT RATED VOLTAGE)
<b>NOISE LEVEL</b>	: 34.6 dB(A) (MAX.: 38.6 dB(A))
<b>LIFE EXPECTANCY</b>	: 70000 Hours at 40°C / 65% RH
<b>NET WEIGHT</b>	: 10 Gram



The standard of Jaro Thermal's fan relative humidity is 65%, and the temperature is 25°C for the standard testing. If you have any question, pls refer to environmental condition on 5-0 first. Other special request pls contact Jaro Thermal for spec checking.



# SPECIFICATION

JARO MODEL: JCD0301012UB1A0E(13000)-X(2310)

## 1-0 MATERIAL

1-1 Frame Material – PBT+30%GF OF UL 94V-0

1-2 Fan Blade Material – PBT+30%GF OF UL 94V-0

1-3 Other material – See 8.0 Dimension Drawing

1-4 Environmental Standard

[ V ] RoHS

[ V ] REACH

[ ] Halogen Free

## 2-0 FAN VOLTAGE CURRENT, LOCK ROTOR, AIR FLOW, STATIC PRESSURE & NOISE DEFINITION

2-1 Start Voltage - By sudden switching ON fan is start to rotate.

2-2 Input Power - Input Power shall be measured after 3 minutes for continuing rotation by rated voltage.

2-3 Rated Current - Rated Current shall be measured after 3 minutes by continuing rotation by rated voltage.

2-4 Rated Speed - Rated Speed shall be measured after 3 minutes for continuing rotation by rated voltage.

2-5 Locked Rotor Current : Locked current shall be measured within one minute of rotor locked, after 3 minutes by continuing rotation at rated voltage in clean air.

2-6 Air Flow & Static Pressure : The air flow data and static pressures should be determined in accordance with AMCA-210 standard or DIN24163 specification in chamber testing and record the test record.

2-7 Noise Level : The measurement of noise level is carried out with reference to CNS8753 in an anechoic chamber with the microphone positioned 1 meter from the air intake. Testing fan shall be hung in clean air .

### Noise Level Measure

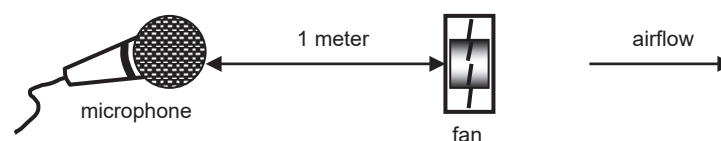



# SPECIFICATION

JARO MODEL: JCD0301012UB1A0E(13000)-X(2310)

## 3-0 FAN FUNCTION DEFINITION

- 3-1 Rotation Direction - Counterclockwise from impeller side.
- 3-2 Lock Rotor Condition  
No damage for winding or electronic in locked rotor condition. And no damage after 72hrs continuing for lock rotor condition.
- 3-3 Auto Restart  
Fan will automatic restart without any abnormal usage.
- 3-4 Dead Angle  
Switch the fan change from off to on condition. Restart the fan, it will automatic restart by fan power on.
- 3-5 Polarity  
Check the voltage and polarity before turn on the power to the fan.
- 3-6 Insulation Resistance  
Do not use < 10M ohm between housing and positive end of lead wire (red) at 500V DC.
- 3-7 Dielectric Strength  
No damage should be found at 500 VAC for 60 seconds, measured with 1mA trip current between housing and positive end of lead wire.

## 4-0 FAN PACKAGE TEST

- 4-1 Free Drop Shock  
Base on Jaro Thermal's standard package, the fan package will test and drops on any three faces - Test standard is 30cm height. The base is wood board for 10mm thick.

## 5-0 FAN ENVIRONMENTAL CONDITION

- 5-1 Operating Temperature / Humidity  
-10°C to +70°C at humidity 5% to 90% Relative humidity.
- 5-2 Humidity  
After 96 hours, 95% RH, 40+/-2°C per MIL-STD-202F, method 103B humidity test, the measured data on insulation resistance and dielectric strength shall meet the specification.
- 5-3 Storage Temperature  
All function shall be normal after 500 hours storage at -40°C to +75 °C with a 24 hour recovery period at room temperature. Humidity 5% to 95% Relative humidity
- 5-4 Do not store this fan in an environment with high humidity. This fan must be stored in accordance with the storage temperature. Do not store the fan for over 6 months; If this fan is stored for more than 6 months, JARO THERMAL recommends functional testing before using.



# SPECIFICATION

JARO MODEL: JCD0301012UB1A0E(13000)-X(2310)

**5-5** Improper way to disassembled fan will cause the fan get into dust or dip into water. Which will in defects is not covered in the warranty. Do not use the fan in the environment with corrosive air or liquid.

## **6-0 MASS PRODUCTION SAMPLE PLAN INSPECTION**

All fans shall meet the quality inspection under MIL-STD-105E standard list as follow:

Critical 0.25%

Major 1.00%

Minor 2.50%

## **7-0 FAN USE WITH CAUTION**

**7-1** Please do not stick a grease and/or an oil to the fan housing or blade which may have a harmful influence by a chemical reaction at high humidity.

**7-2** If the fan is reinstalled, please pay special attention to the noise due to the vibration (or resonance).

**7-3** During the testing of the fan, please make sure the finger guard is use for your safety.

**7-4** While the fan is running, please do not lock the fan intentionally for a long time. This will cause overheating by long period locking status. This action will damage the fan.

**7-5** Please do not touch and push Fan Blade with fingers or others, fan blade and ball bearings may be damaged and it causes noise defect.

**7-6** Do not carry the fan by its lead wires.

**7-7** If the fan does not have the polarity protection function, the connection of the colored wires should be red + red, and black + black, or else the fan will be damaged in no time.

**7-8** For the models without reverse connection of polarity protection, please do not connect the lead wire in reverse position.

**7-9** Please don't install this fan in series with 2x voltage inputs. For example, if a single fan rated at 12V, then don't install two of them in series with 24V input.

**7-10** Every specific fan is designed for its certain application (project). Therefore, if you want to use this fan in other application (project), please inform JARO first so that we can confirm whether there is any issue which might be incurred from the reason of this different application (project) or not.

**7-11** The "Life Expectancy" of this fan has not been evaluated for use in combination with any end application. Therefore, the Life Expectancy in the Test Reports(L10 and MTTF Report) that relate to this fan is for reference only and shall not construe any kind of warranty of JARO to the life of any specific fan , either expressed or implied.

**7-12** The period of product warranty , unless otherwise agreed by JARO in written , shall be 12 months staring from the date of production.



# DIMENSION DRAWING

JARO MODEL: JCD0301012UB1A0E(13000)-X(2310)

## 8-0 DIMENSIONS

All dimensions, Direction of rotation and air flow were specified as per drawing attached.

### Description: DC Fan with:

Lead Wire: UL3302 AWG#28, 76±5mm lead length.

RED WIRE----- ( + )

BLACK WIRE----- ( - )

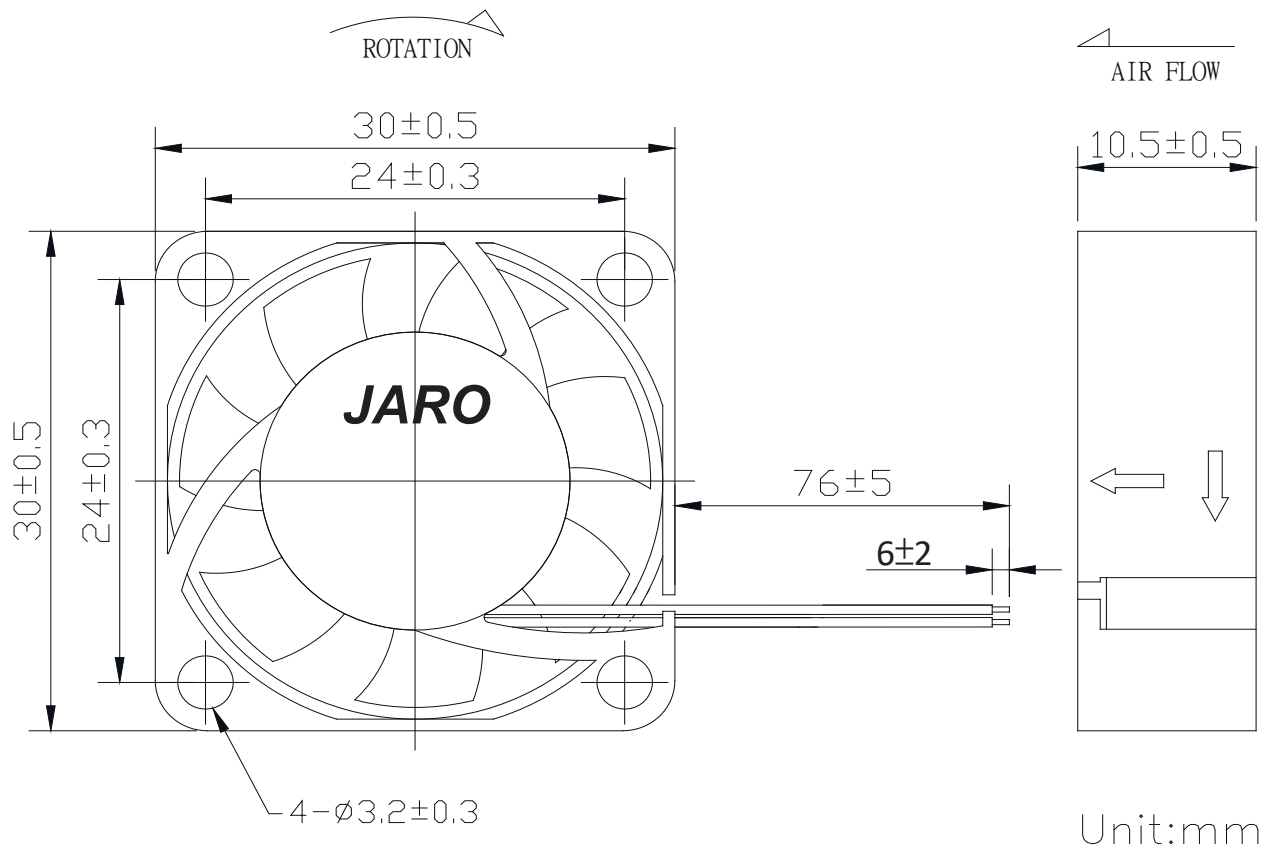

**DIAGRAM OF DIMENSIONS: Dimensions in millimeters  
NOT TO SCALE. ALL COMPONENTS MUST BE RoHS/REACH COMPLIANT.**

**Drawing Note: N/A**

**Safety : UL/CUL/CE**



# JARO LABEL DRAWING

JARO MODEL: JCD0301012UB1A0E(13000)-X(2310)

## Label Drawing

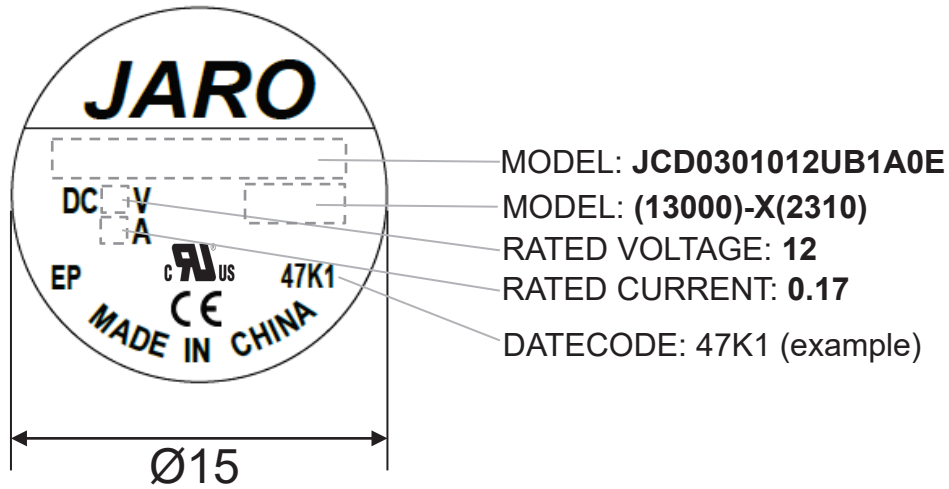

Label Material	Dimension	Background color
PET	$\varnothing=15\text{mm}$	Silver



# PERFORMANCE CURVE

JARO MODEL: JCD0301012UB1A0E(13000)-X(2310)

## 9-0 PERFORMANCE CURVE

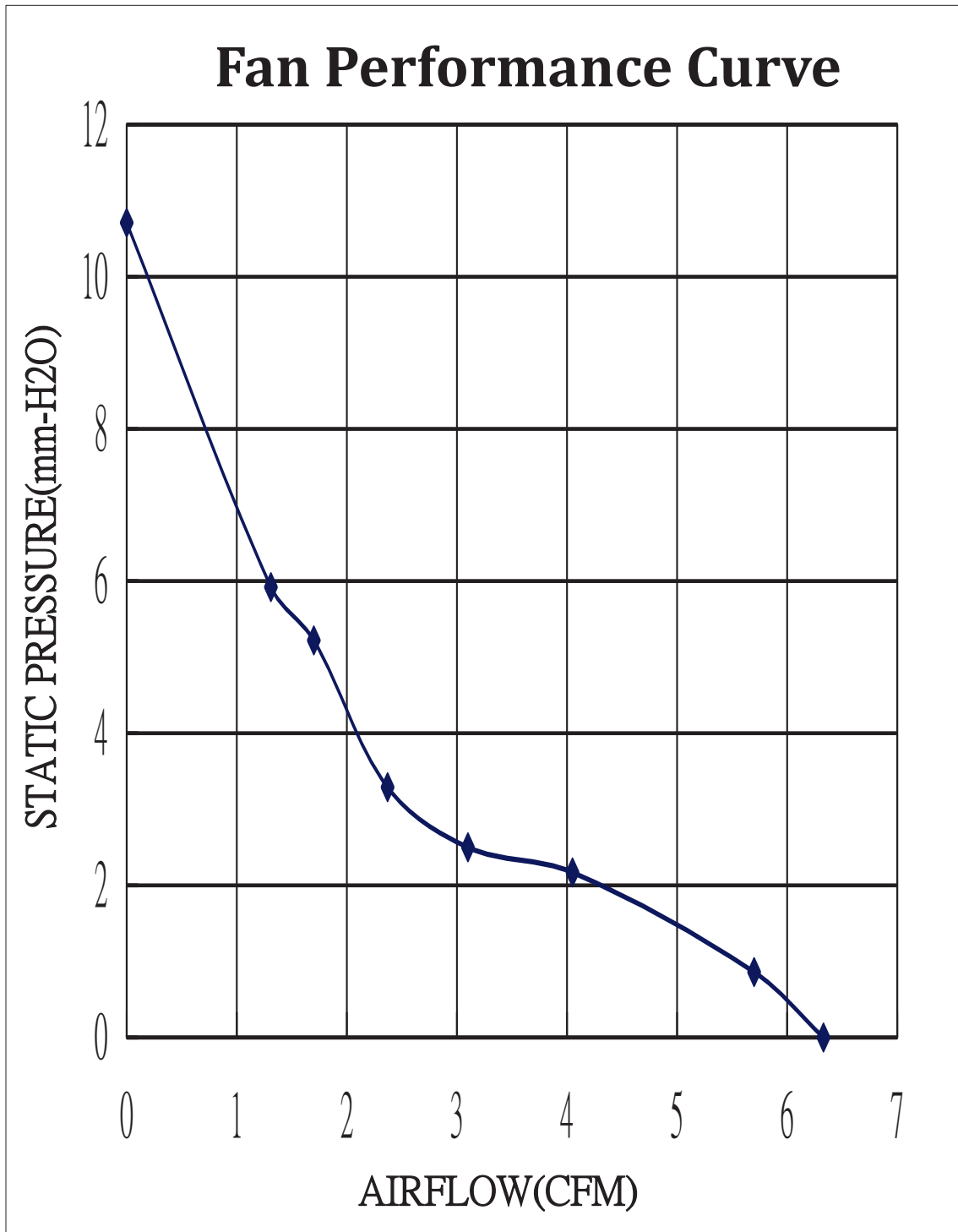



# LIFE EXPECTANCY

JARO MODEL: JCD0301012UB1A0E(13000)-X(2310)

## 10-0 LIFE EXPECTANCY

故障定義 Product Specification & Failure Definition	試驗結果：包含故障時間、數據、統計、...等 Test Result : Including Time Of Failure · Datum · Statistics · ... ect.																																														
1.風扇不轉 (Fan Not Work) 2.轉速超出規格30% (Speed Over 30% Origin) 3.電流超出規格30% (Current Over 30% Origin)	$\text{TEMP A.F} = e^{(\Delta H/K) \times (\frac{1}{273+Tl} - \frac{1}{273+Th})}$ <ul style="list-style-type: none"> <li>溫度加速因子 TEMP A.F =</li> <li>總試驗時間 Total Test Time = 200000 HRS.</li> <li>查表得 (MTTF By GEM Table) MTTF = 86858 HRS.</li> </ul>																																														
Description : 1.性能測試時點 The Time Of Check Point Start : 0Hr, 500Hrs, 1000Hrs And Finished $70^{\circ}\text{C MTTF} = \frac{\text{Total test time (T)}}{\text{Total failure (r)}}$ 2. Generalized Exponential Model (for Time-Terminated Test) <table border="1" data-bbox="194 892 560 997"> <thead> <tr> <th>r</th> <th>0</th> <th>1</th> <th>2</th> <th>3</th> <th>4</th> <th>5</th> </tr> </thead> <tbody> <tr> <td>M</td> <td>2.3026</td> <td>3.8897</td> <td>5.3223</td> <td>6.6808</td> <td>7.99364</td> <td>9.2747</td> </tr> <tr> <th>r</th> <th>6</th> <th>7</th> <th>8</th> <th>9</th> <th>10</th> <th></th> </tr> <tr> <td>M</td> <td>10.5321</td> <td>11.7709</td> <td>12.9947</td> <td>14.2060</td> <td>15.4066</td> <td></td> </tr> </tbody> </table>	r	0	1	2	3	4	5	M	2.3026	3.8897	5.3223	6.6808	7.99364	9.2747	r	6	7	8	9	10		M	10.5321	11.7709	12.9947	14.2060	15.4066		<ul style="list-style-type: none"> <li>溫度 / TEMP. / MTTF / L10</li> </ul> <table border="1" data-bbox="771 766 1356 997"> <thead> <tr> <th>溫度TE MP.</th> <th>信賴水準90% CONFIDENCE LEVEL</th> <th>L10</th> </tr> </thead> <tbody> <tr> <td>30 °C</td> <td>1559455</td> <td>164153</td> </tr> <tr> <td>40 °C</td> <td>706937</td> <td>74414</td> </tr> <tr> <td>50 °C</td> <td>336561</td> <td>35427</td> </tr> <tr> <td>60 °C</td> <td>167535</td> <td>17635</td> </tr> <tr> <td>70 °C</td> <td>86858</td> <td>9143</td> </tr> </tbody> </table> <p>3. Herewith, we could assume as right on the basis of above test result. Besides, if the actual test time exceed the required, it comes out that those fans' L<sub>10</sub> expectancy and MTTF are greater than the warrant.          MTTF: Mean Time To Failures. It should be used in a non-repairable system setting. Now we show the MTTF in our life report, that's because we will not repair the failed fans during life experiment. MTBF: Mean Time Between Failures. It should be used in a repairable system setting. Basically, MTBF is equal to MTTF, they use same formula to work out a life data.</p>	溫度TE MP.	信賴水準90% CONFIDENCE LEVEL	L10	30 °C	1559455	164153	40 °C	706937	74414	50 °C	336561	35427	60 °C	167535	17635	70 °C	86858	9143
r	0	1	2	3	4	5																																									
M	2.3026	3.8897	5.3223	6.6808	7.99364	9.2747																																									
r	6	7	8	9	10																																										
M	10.5321	11.7709	12.9947	14.2060	15.4066																																										
溫度TE MP.	信賴水準90% CONFIDENCE LEVEL	L10																																													
30 °C	1559455	164153																																													
40 °C	706937	74414																																													
50 °C	336561	35427																																													
60 °C	167535	17635																																													
70 °C	86858	9143																																													

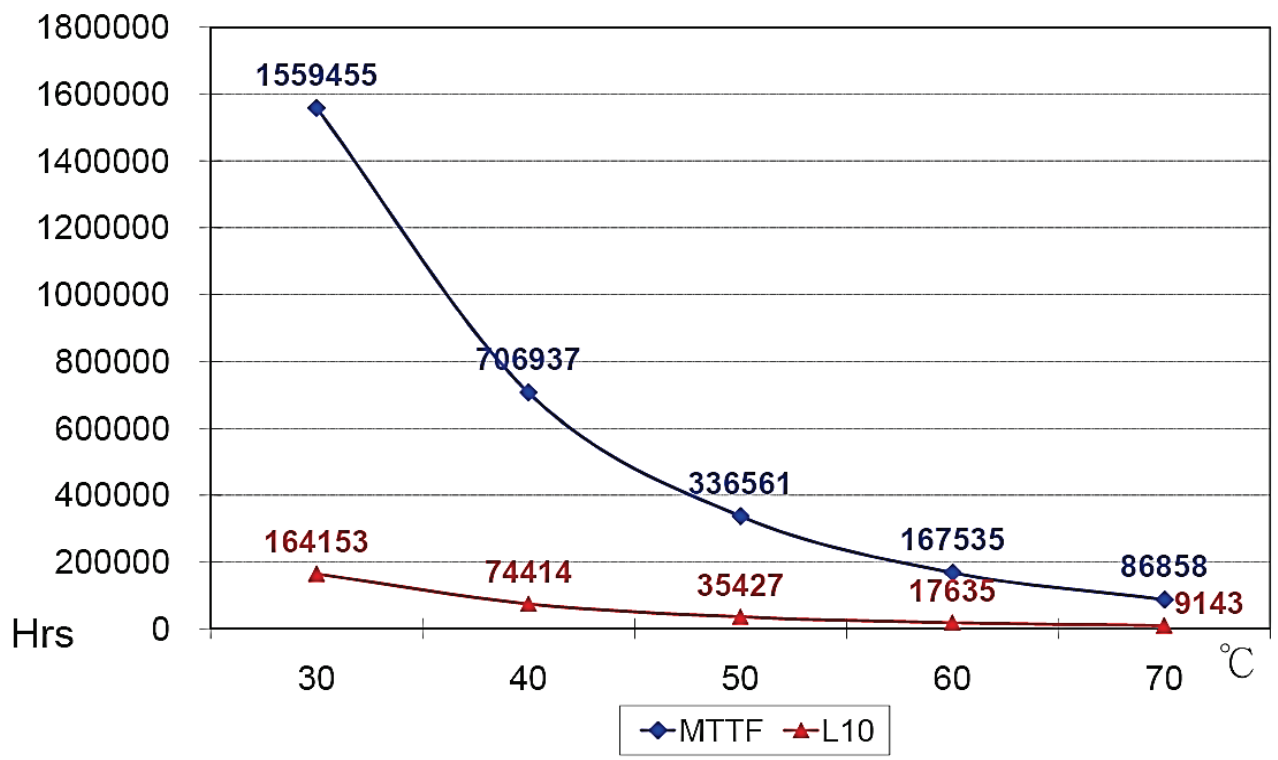



JARO MODEL: JCD0301012UB1A0E(13000)-X(2310)

## NOTICE FOR OPERATION

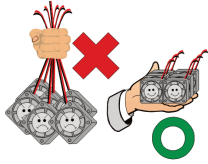

1

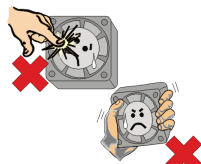

2

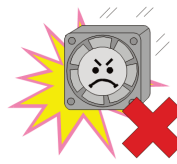

3



4

1. Hold the fan by frame side.  
Do not hold lead wires.(Fig.1)
2. Do not touch or press on the impeller.  
Do not crush the frame. (Fig.2)
3. Do not drop the fan on the ground.  
Hit the frame may cause the fan damaged. (Fig.3)
4. Connect the power cord properly and apply voltage according to specification. (Fig.4)

## NOTICE FOR ASSEMBLY AND AMBIENT CONDITIONS

1. When applying our fan your device, please check thoroughly any variation of EMC, temperature rise, life data, quality, etc. of this product by shock/drop/vibration testing, etc. If there is any problem or accident in connection with this product, it should be mutually discussed and checked by both parties.
2. Take proper care for handling this fan. Components such as fan holders or bearings may be damaged by fingers touch or other objects. Additionally, static electricity (ESD) may damage the internal circuits of the fan.
3. DO NOT operate this fan in proximity to hazardous materials such as organic silicon, cyanogen, formalin, phenol, or corrosive gas environments. Any hazardous materials flow to the fan side may cause damaged or malfunction.
4. JARO recommends that you protect this fan from exposure to outside elements such as dust, condensation, humidity or insects.  
Exposure of this fan to outside elements such as dust, condensation, humidity or insects may affect its performance and may cause safety hazards. JARO does not guarantee the damage to the product caused by outside elements.
5. This fan must be installed properly and securely. Improper mounting may cause harsh resonance, vibration, and noise. If you have any question about fan mounting, please discuss with JARO if you are not sure the correct mounting method.
6. DO NOT use or store the fan with higher humidity and temperature specified in spec.  
The fan must be stored with the attached specifications regarding storage temperature. If this fan is stored for more than 6 months, JARO recommends to perform functional testing before using. Please contact JARO if you are not sure how to perform functional test.
7. The "Life Expectancy" of this fan has not been evaluated for use in combination with any end application. Therefore, the Life Expectancy Test Reports (L10 and MTTF Report) that relate to this fan are only for reference.
8. Fan guards may prevent injury during handling or installation of the fan.