



We Keep the World Cool™

JARO Thermal is a recognized leader in the electronic thermal management field.

For more than 39 years, JARO has developed a broad range of unique, cutting-edge cooling technologies designed to extend the life of electronic components for many different industries. Our commitment to product, people and technological innovation will advance our quest for superior products and services to deliver the quality our customers require.

2023 HEAT SINK CATALOG

★ **LED HEATSINKS**

JtraLED Series Page 02~03
 JFanLED Series Page 04
 JXLED Series Page 05~06
 JGOLED Series Page 07~08

★ **FORGED PIN FIN HEATSINKS**

Round Series Page 09~15
 Quadrilateral Series Page 16

★ **EXTRUDED HEATSINKS**

PCB Mount Series Page 17~22
 BGA Series Page 23~24
 Extruded Profiles Page 25~31

★ **STAMPED HEATSINKS**

Stamped Heatsinks Page 32~38

★ **HEATSINK ACCESSORIES**

Clip Page 39

JtraLED Series

LED HEATSINKS

4820 / 4850 / 4880

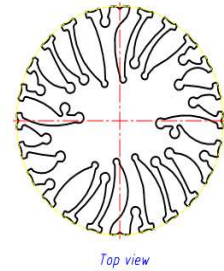
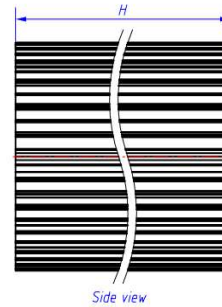
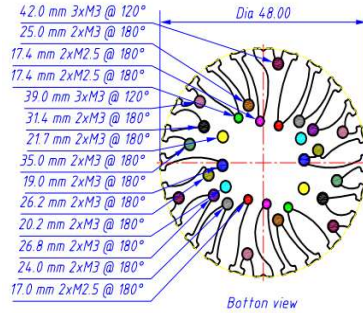

Star Heat Sinks Φ 48mm for COB Modular Product Brief

- * Mechanical compatibility with direct mounting of the LED modules to the LED cooler and thermal performance matching the lumen packages.
- * Thermal resistance range R_{th} (7.69°C/W; 5.0°C/W; 4.17°C/W).
- * Modular design with mounting holes foreseen for direct mounting of a wide range of LED modules and COB's.
- * Diameter 48mm - Standard height 20.0mm / 50.0mm / 80.0mm , Other heights on request.
- * Extruded from highly conductive aluminum AL6063-T5.

Order Information

Example: JtraLED-4820-B

JtraLED - 48

Height (mm)	Anodized Color
20	B : Black
50	C : Clear
80	Z : Custom

7020 / 7050 / 7080

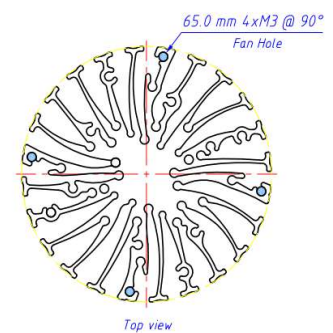
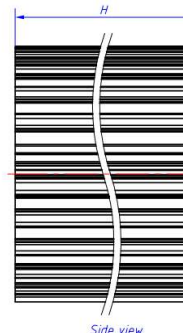
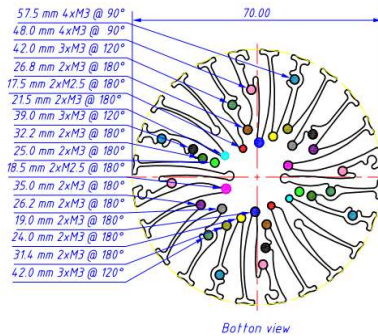

Star Heat Sinks Φ 70mm for COB Modular Product Brief

- * Mechanical compatibility with direct mounting of the LED modules to the LED cooler and thermal performance matching the lumen packages.
- * Thermal resistance range R_{th} (3.7°C/W; 2.5°C/W; 2.08°C/W).
- * Modular design with mounting holes foreseen for direct mounting of a wide range of LED modules and COB's.
- * Diameter 70mm - Standard height 20.0mm / 50.0mm / 80.0mm , Other heights on request.
- * Extruded from highly conductive aluminum AL6063-T5.

Order Information

Example: JtraLED-7020-B

JtraLED - 70

Height (mm)	Anodized Color
20	B : Black
50	C : Clear
80	Z : Custom

8520 / 8550 / 8580

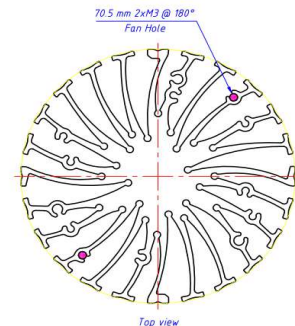
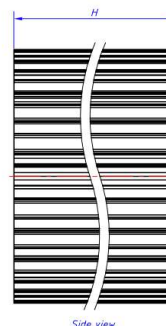
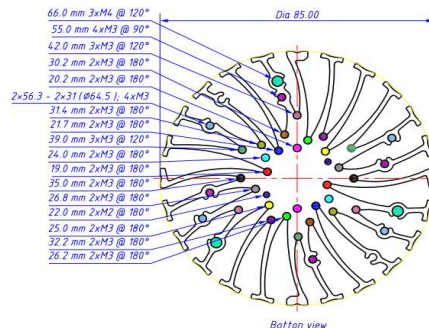

Star Heat Sinks Φ 85mm for COB Modular Product Brief

- * Mechanical compatibility with direct mounting of the LED modules to the LED cooler and thermal performance matching the lumen packages.
- * Thermal resistance range R_{th} (2.38°C/W; 1.72°C/W; 1.47°C/W).
- * Modular design with mounting holes foreseen for direct mounting of a wide range of LED modules and COB's.
- * Diameter 85mm - Standard height 20.0mm / 50.0mm / 80.0mm , Other heights on request.
- * Extruded from highly conductive aluminum AL6063-T5.

Order Information

Example: JtraLED-8520-B

JtraLED - 85

Height (mm)	Anodized Color
20	B : Black
50	C : Clear
80	Z : Custom

JtraLED Series

LED HEATSINKS

9620 / 9650 / 9680

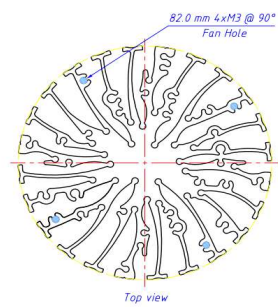
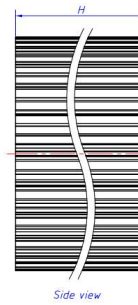
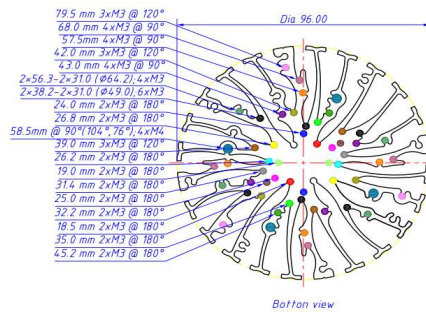

Star Heat Sinks Ø96mm for COB Modular Product Brief

- * Mechanical compatibility with direct mounting of the LED modules to the LED cooler and thermal performance matching the lumen packages.
- * Thermal resistance range Rth(2.08°C/W; 1.45°C/W; 1.2°C/W).
- * Modular design with mounting holes foreseen for direct mounting of a wide range of LED modules and COB's.
- * Diameter 96mm - Standard height 20.0mm / 50.0mm / 80.0mm , Other heights on request.
- * Extruded from highly conductive aluminum AL6063-T5.

Order Information

Example: JtraLED-9620-B

JtraLED - 96 [] - []

Hight (mm)	Anodized Color
20	B : Black
50	C : Clear
80	Z : Custom

11020 / 11050 / 11080

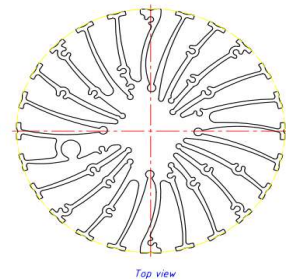
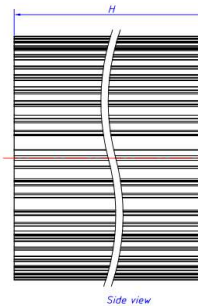
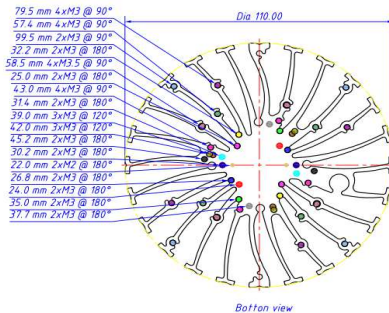
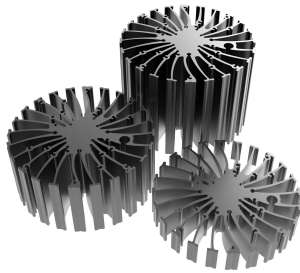

Star Heat Sinks Ø110mm for COB Modular Product Brief

- * Mechanical compatibility with direct mounting of the LED modules to the LED cooler and thermal performance matching the lumen packages.
- * Thermal resistance range Rth(1.79°C/W; 1.22°C/W; 1.03°C/W).
- * Modular design with mounting holes foreseen for direct mounting of a wide range of LED modules and COB's.
- * Diameter 110mm - Standard height 20.0mm / 50.0mm / 80.0mm , Other heights on request.
- * Extruded from highly conductive aluminum AL6063-T5.

Order Information

Example: JtraLED-11020-B

JtraLED - 110 [] - []

Hight (mm)	Anodized Color
20	B : Black
50	C : Clear
80	Z : Custom

13020 / 13050 / 13080

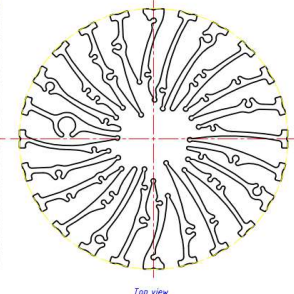
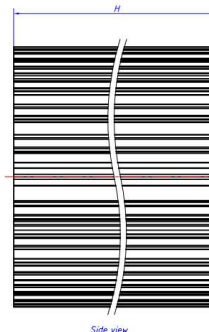
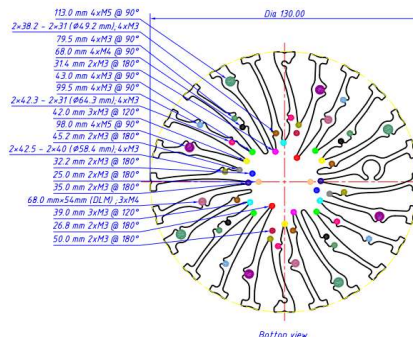
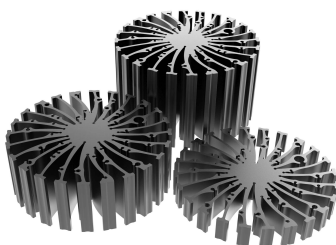

Star Heat Sinks Ø130mm for COB Modular Product Brief

- * Mechanical compatibility with direct mounting of the LED modules to the LED cooler and thermal performance matching the lumen packages.
- * Thermal resistance range Rth(1.39°C/W; 1.02°C/W; 0.83°C/W).
- * Modular design with mounting holes foreseen for direct mounting of a wide range of LED modules and COB's.
- * Diameter 130mm - Standard height 20.0mm / 50.0mm / 80.0mm , Other heights on request.
- * Extruded from highly conductive aluminum AL6063-T5.

Order Information

Example: JtraLED-13020-B

JtraLED - 130 [] - []

Hight (mm)	Anodized Color
20	B : Black
50	C : Clear
80	Z : Custom

JFanLED Series

LED HEATSINKS

3820 / 3850 / 3880

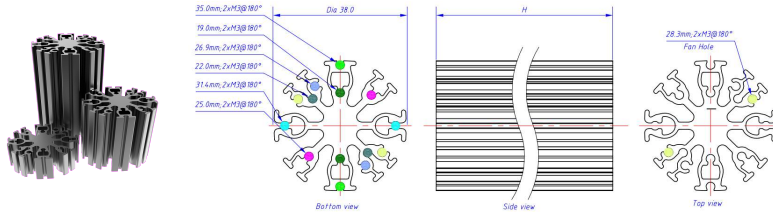

Star Heat Sinks Φ 38mm for COB Modular Product Brief

- * Mechanical compatibility with direct mounting of the LED modules to the LED cooler and thermal performance matching the lumen packages.
- * Thermal resistance range R_{th} (10.9°C/W; 6.9°C/W; 5.2°C/W).
- * Modular design with mounting holes foreseen for direct mounting of a wide range of LED modules and COB's.
- * Diameter 38mm - Standard height 20.0mm / 50.0mm / 80.0mm , Other heights on request.
- * Extruded from highly conductive aluminum AL6063-T5.

Order Information

Example: JFanLED-3820-B

JFanLED - 38

Hight (mm)	Anodized Color
20	B : Black
50	C : Clear
80	Z : Custom

7020 / 7050 / 7080

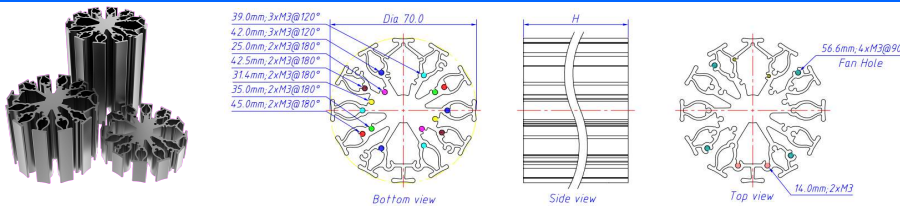

Star Heat Sinks Φ 70mm for COB Modular Product Brief

- * Mechanical compatibility with direct mounting of the LED modules to the LED cooler and thermal performance matching the lumen packages.
- * Thermal resistance range R_{th} (3.7°C/W; 2.3°C/W; 1.9°C/W).
- * Modular design with mounting holes foreseen for direct mounting of a wide range of LED modules and COB's.
- * Diameter 70mm - Standard height 20.0mm / 50.0mm / 80.0mm , Other heights on request.
- * Extruded from highly conductive aluminum AL6063-T5.

Order Information

Example: JFanLED-7020-B

JFanLED - 70

Hight (mm)	Anodized Color
20	B : Black
50	C : Clear
80	Z : Custom

8520 / 8550 / 8580

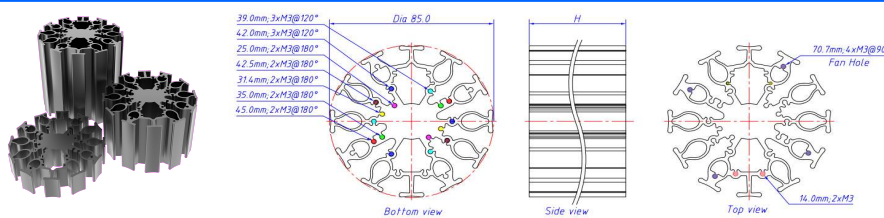

Star Heat Sinks Φ 85mm for COB Modular Product Brief

- * Mechanical compatibility with direct mounting of the LED modules to the LED cooler and thermal performance matching the lumen packages.
- * Thermal resistance range R_{th} (2.6°C/W; 1.7°C/W; 1.3°C/W).
- * Modular design with mounting holes foreseen for direct mounting of a wide range of LED modules and COB's.
- * Diameter 85mm - Standard height 20.0mm / 50.0mm / 80.0mm , Other heights on request.
- * Extruded from highly conductive aluminum AL6063-T5.

Order Information

Example: JFanLED-8520-B

JFanLED - 85

Hight (mm)	Anodized Color
20	B : Black
50	C : Clear
80	Z : Custom

9620 / 9650 / 9680

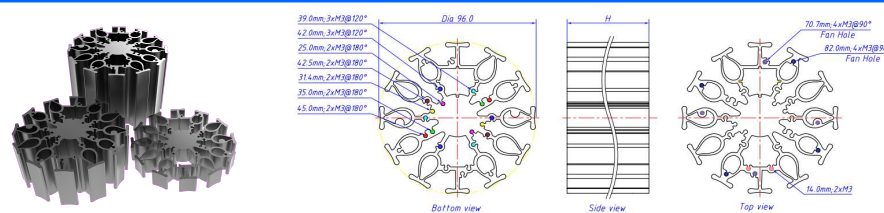

Star Heat Sinks Φ 96mm for COB Modular Product Brief

- * Mechanical compatibility with direct mounting of the LED modules to the LED cooler and thermal performance matching the lumen packages.
- * Thermal resistance range R_{th} (2.2°C/W; 1.3°C/W; 1.0°C/W).
- * Modular design with mounting holes foreseen for direct mounting of a wide range of LED modules and COB's.
- * Diameter 96mm - Standard height 20.0mm / 50.0mm / 80.0mm , Other heights on request.
- * Extruded from highly conductive aluminum AL6063-T5.

Order Information

Example: JFanLED-9620-B

JFanLED - 96

Hight (mm)	Anodized Color
20	B : Black
50	C : Clear
80	Z : Custom

JXLED Series

LED HEATSINKS

4530 / 4550 / 4568

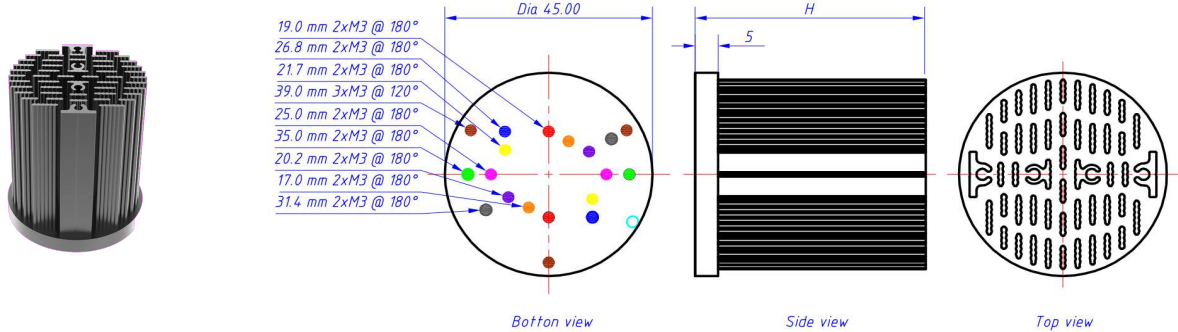

Slot Fins Heat Sink Φ 45mm for COB Modular Product Brief

- * Mechanical compatibility with direct mounting of the LED modules to the LED cooler and thermal performance matching the lumen packages.
- * Thermal resistance range $R_{th}(7.14^{\circ}\text{C/W}; 5.55^{\circ}\text{C/W}; 4.60^{\circ}\text{C/W})$.
- * Modular design with mounting holes foreseen for direct mounting of a wide range of LED modules and COB's.
- * Diameter 45mm - Standard height 30.0mm / 50.0mm / 68.0mm , Other heights on request.
- * Forged from highly conductive aluminum AL1070.

Order Information

Example: JXLED-4530-B

JXLED - 45

Height (mm)	Anodized Color
30	B : Black
50	C : Clear
68	Z : Custom

6030 / 6050 / 6080

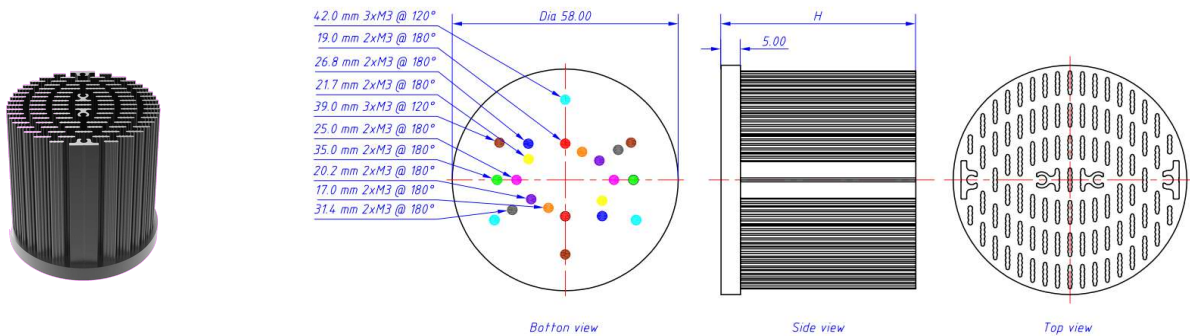

Slot Heat Sinks Φ 60mm for COB Modular Product Brief

- * Mechanical compatibility with direct mounting of the LED modules to the LED cooler and thermal performance matching the lumen packages.
- * Thermal resistance range $R_{th}(5.0^{\circ}\text{C/W}; 3.85^{\circ}\text{C/W}; 4.17^{\circ}\text{C/W})$.
- * Modular design with mounting holes foreseen for direct mounting of a wide range of LED modules and COB's.
- * Diameter 60mm - Standard height 30.0mm / 50.0mm / 80.0mm , Other heights on request.
- * Forged from highly conductive aluminum AL1070.

Order Information

Example: JXLED-6030-B

JXLED - 60

Height (mm)	Anodized Color
30	B : Black
50	C : Clear
80	Z : Custom

7030 / 7050 / 7080

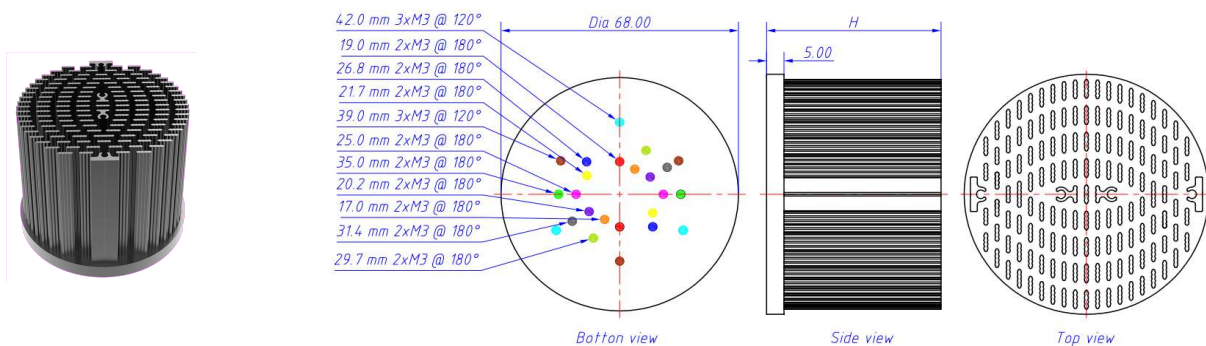

Slot Heat Sinks Φ 70mm for COB Modular Product Brief

- * Mechanical compatibility with direct mounting of the LED modules to the LED cooler and thermal performance matching the lumen packages.
- * Thermal resistance range $R_{th}(3.85^{\circ}\text{C/W}; 3.13^{\circ}\text{C/W}; 1.98^{\circ}\text{C/W})$.
- * Modular design with mounting holes foreseen for direct mounting of a wide range of LED modules and COB's.
- * Diameter 70mm - Standard height 30.0mm / 50.0mm / 80.0mm , Other heights on request.
- * Forged from highly conductive aluminum AL1070.

Order Information

Example: JXLED-7030-B

JXLED - 70

Height (mm)	Anodized Color
30	B : Black
50	C : Clear
80	Z : Custom

JXLED Series

LED HEATSINKS

8030 / 8050 / 8088

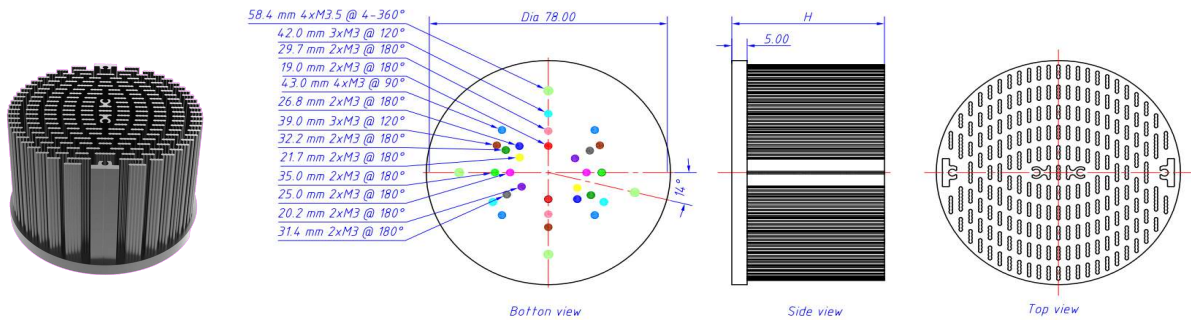

Slot Fins Heat Sink Ø80mm for COB Modular Product Brief

- * Mechanical compatibility with direct mounting of the LED modules to the LED cooler and thermal performance matching the lumen packages.
- * Thermal resistance range Rth(3.13°C/W; 2.38°C/W; 2.08°C/W).
- * Modular design with mounting holes foreseen for direct mounting of a wide range of LED modules and COB's.
- * Diameter 80mm - Standard height 30.0mm / 50.0mm / 80.0mm , Other heights on request.
- * Forged from highly conductive aluminum AL1070.

Order Information

Example: JXLED-8030-B

JXLED - 80

Height (mm)	Anodized Color
30	B : Black
50	C : Clear
80	Z : Custom

16530 / 16560 / 165100

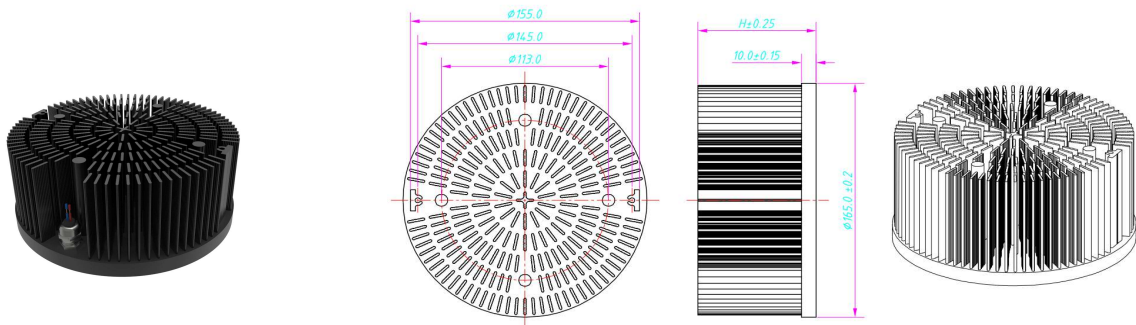

Passive Pin Fin Heatsink Ø165mm

- * Mechanical compatibility with direct mounting of the SMD products to the LED cooler and thermal performance matching the lumen packages.
- * Thermal resistance range Rth(0.91°C/W; 0.55°C/W; 0.42°C/W).
- * Diameter 165mm - Standard height 30.0mm / 60.0mm / 100.0mm , Other heights on request.
- * Forged from highly conductive aluminum AL1070.

Order Information

Example: JXLED-16530-B

JXLED - 165

Height (mm)	Anodized Color
30	B : Black
60	C : Clear
100	Z : Custom

22530 / 22560 / 225100

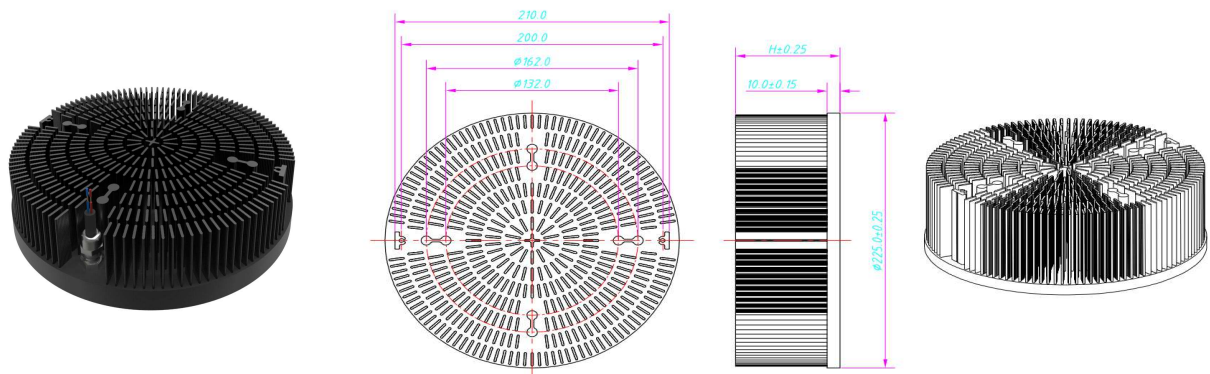

Passive Pin Fin Heatsink Ø225mm

- * Mechanical compatibility with direct mounting of the SMD products to the LED cooler and thermal performance matching the lumen packages.
- * Thermal resistance range Rth(0.63°C/W; 0.34°C/W; 0.26°C/W).
- * Diameter 225mm - Standard height 30.0mm / 60.0mm / 100.0mm , Other heights on request.
- * Forged from highly conductive aluminum AL1070.

Example: JXLED-22530-B

JXLED - 225

Height (mm)	Anodized Color
30	B : Black
60	C : Clear
100	Z : Custom

JGOLED Series

LED HEATSINKS

4830 / 4850 / 4868

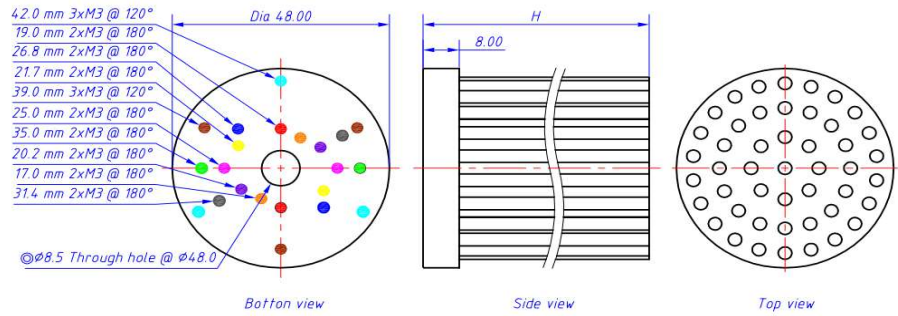

Pin Fin Sinks Φ48mm for COB Modular Product Brief

- * Mechanical compatibility with direct mounting of the LED modules to the LED cooler and thermal performance matching the lumen packages.
- * Thermal resistance range Rth(6.25°C/W; 5.0°C/W; 4.17°C/W).
- * Modular design with mounting holes foreseen for direct mounting of a wide range of LED modules and COB's.
- * Diameter 48mm - Standard height 30.0mm / 50.0mm / 68.0mm , Other heights on request.
- * Forged from highly conductive aluminum AL1070.

Order Information

Example:JGOLED-4830-B

JGOLED - 48 [Diagram showing height and color options]

Height (mm)	Anodized Color
30	B : Black
50	C : Clear
68	Z : Custom

5830 / 5850 / 5880

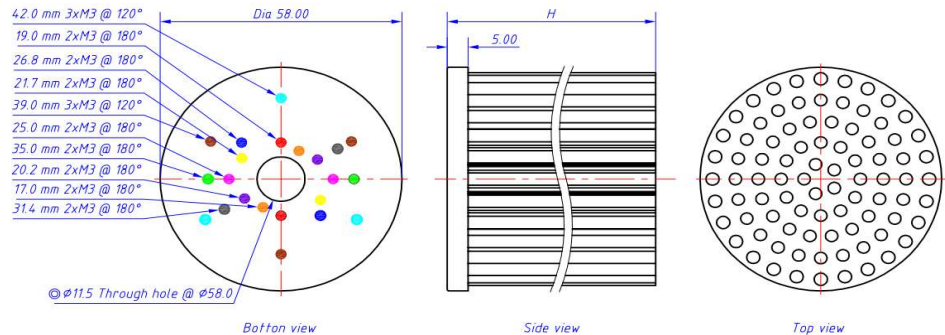

Pin Fin Sinks Φ58mm for COB Modular Product Brief

- * Mechanical compatibility with direct mounting of the LED modules to the LED cooler and thermal performance matching the lumen packages.
- * Thermal resistance range Rth(5.0°C/W; 3.85°C/W; 3.34°C/W).
- * Modular design with mounting holes foreseen for direct mounting of a wide range of LED modules and COB's.
- * Diameter 58mm - Standard height 30.0mm / 50.0mm / 80.0mm , Other heights on request.
- * Forged from highly conductive aluminum AL1070.

Order Information

Example:JGOLED-5830-B

JGOLED - 58 [Diagram showing height and color options]

Height (mm)	Anodized Color
30	B : Black
50	C : Clear
80	Z : Custom

6830 / 6850 / 6880

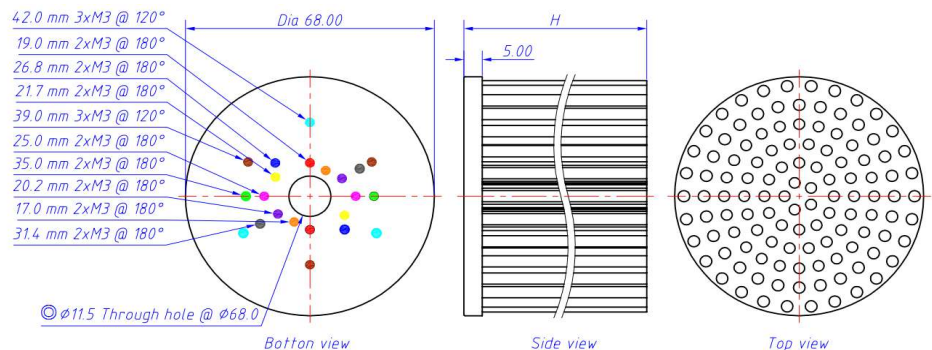

Pin Fin Sinks Φ68mm for COB Modular Product Brief

- * Mechanical compatibility with direct mounting of the LED modules to the LED cooler and thermal performance matching the lumen packages.
- * Thermal resistance range Rth(4.0°C/W; 3.23°C/W; 3.08°C/W).
- * Modular design with mounting holes foreseen for direct mounting of a wide range of LED modules and COB's.
- * Diameter 68mm - Standard height 30.0mm / 50.0mm / 80.0mm , Other heights on request.
- * Forged from highly conductive aluminum AL1070.

Order Information

Example:JGOLED-6830-B

JGOLED - 68 [Diagram showing height and color options]

Height (mm)	Anodized Color
30	B : Black
50	C : Clear
80	Z : Custom

JGOLED Series

LED HEATSINKS

7830 / 7850 / 7880

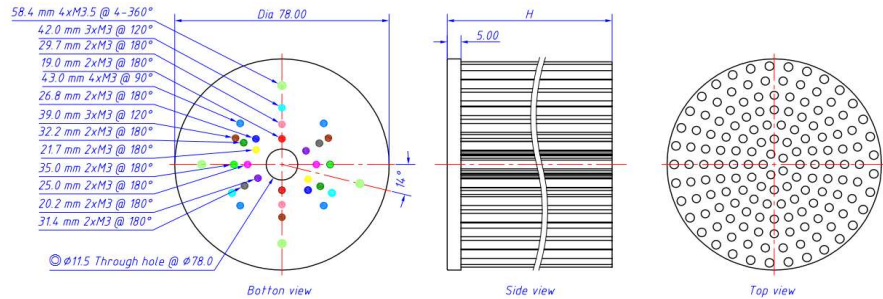

Pin Fin Sinks Φ 78mm for COB Modular Product Brief

- * Mechanical compatibility with direct mounting of the LED modules to the LED cooler and thermal performance matching the lumen packages.
- * Thermal resistance range $R_{th}(3.03^{\circ}C/W; 2.33^{\circ}C/W; 2.08^{\circ}C/W)$.
- * Modular design with mounting holes foreseen for direct mounting of a wide range of LED modules and COB's.
- * Diameter 78mm - Standard height 30.0mm / 50.0mm / 80.0mm , Other heights on request.
- * Forged from highly conductive aluminum AL1070.

Order Information

Example: JGOLED-7830-B

JGOLED - 78 [Diagram showing pin fin height options]

Height (mm)	Anodized Color
30	B : Black
50	C : Clear
80	Z : Custom

8630 / 8650 / 8665

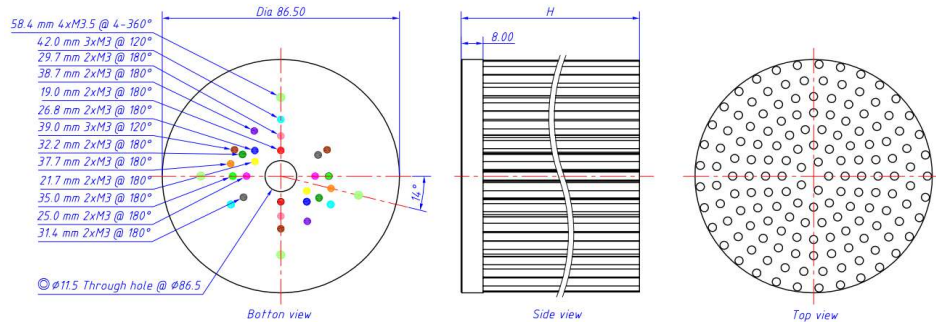

Pin Fin Sinks Φ 86mm for COB Modular Product Brief

- * Mechanical compatibility with direct mounting of the LED modules to the LED cooler and thermal performance matching the lumen packages.
- * Thermal resistance range $R_{th}(2.5^{\circ}C/W; 1.85^{\circ}C/W; 1.56^{\circ}C/W)$.
- * Modular design with mounting holes foreseen for direct mounting of a wide range of LED modules and COB's.
- * Diameter 86mm - Standard height 30.0mm / 50.0mm / 65.0mm , Other heights on request.
- * Forged from highly conductive aluminum AL1070.

Order Information

Example: JGOLED-8630-B

JGOLED - 86 [Diagram showing pin fin height options]

Height (mm)	Anodized Color
30	B : Black
50	C : Clear
65	Z : Custom

11050 / 11080 / 110100

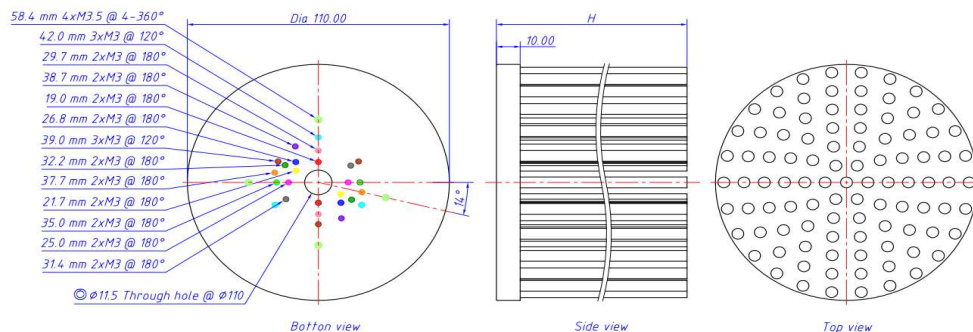

Pin Fin Sinks Φ 110mm for COB Modular Product Brief

- * Mechanical compatibility with direct mounting of the LED modules to the LED cooler and thermal performance matching the lumen packages.
- * Thermal resistance range $R_{th}(1.47^{\circ}C/W; 1.14^{\circ}C/W; 1.0^{\circ}C/W)$.
- * Modular design with mounting holes foreseen for direct mounting of a wide range of LED modules and COB's.
- * Diameter 110mm - Standard height 50.0mm / 80.0mm / 100.0mm , Other heights on request.
- * Forged from highly conductive aluminum AL1070.

Order Information

Example: JGOLED-11050-B

JGOLED - 110 [Diagram showing pin fin height options]

Height (mm)	Anodized Color
50	B : Black
80	C : Clear
100	Z : Custom

Round Series (Dia.150mm ↑)

FORGED PIN FIN HEATSINKS

JCHAF0011



Dimensions (mm) : D151 / H60 / T10
 Material : AL 1050 / 1060 / 1070 / 6063
 Finish : Anodized / Clean

JCHAF0012



Dimensions (mm) : D151 / H50 / T5
 Material : AL 1050 / 1060 / 1070 / 6063
 Finish : Anodized / Clean

JCHAF0036

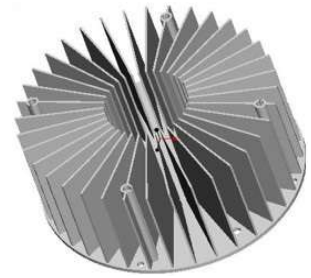

Dimensions (mm) : D152 / H73.7 / T3
 Material : AL 1050 / 1060 / 1070 / 6063
 Finish : Anodized / Clean

JCHAF0044

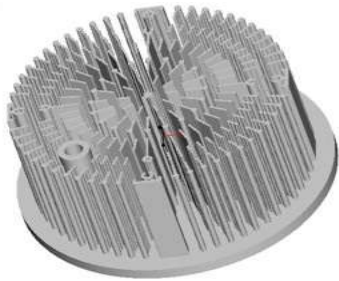

Dimensions (mm) : D180 / H80 / T8
 Material : AL 1050 / 1060 / 1070 / 6063
 Finish : Anodized / Clean

JCHAF0045



Dimensions (mm) : D209 / H50 / T7
 Material : AL 1050 / 1060 / 1070 / 6063
 Finish : Anodized / Clean

JCHAF0047

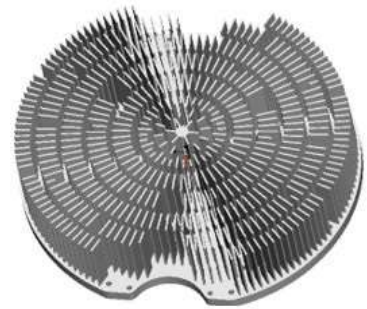

Dimensions (mm) : D210 / H35 / T5
 Material : AL 1050 / 1060 / 1070 / 6063
 Finish : Anodized / Clean

JCHAF0053

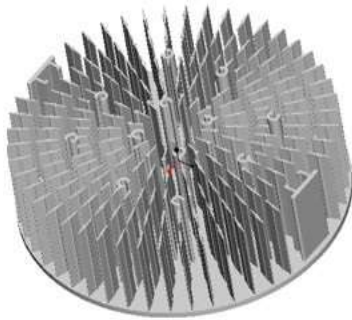

Dimensions (mm) : D220 / H70 / T5
 Material : AL 1050 / 1060 / 1070 / 6063
 Finish : Anodized / Clean

JCHAF0054



Dimensions (mm) : D165 / H60 / T25
 Material : AL 1050 / 1060 / 1070 / 6063
 Finish : Anodized / Clean

JCHAF0073



Dimensions (mm) : D167.5 / H90
 Material : AL 1050 / 1060 / 1070 / 6063
 Finish : Anodized / Clean

JCHAF0076

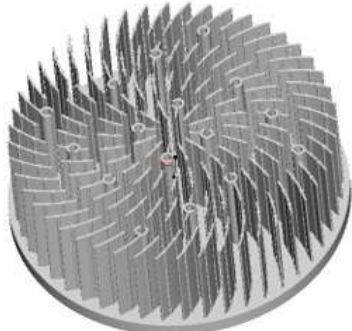

Dimensions (mm) : D224 / H73
 Material : AL 1050 / 1060 / 1070 / 6063
 Finish : Anodized / Clean

JCHAF0081

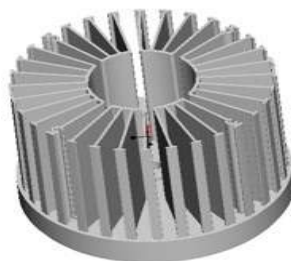

Dimensions (mm) : D180 / H120
 Material : AL 1050 / 1060 / 1070 / 6063
 Finish : Anodized / Clean

JCHAF0082

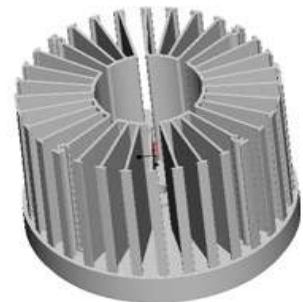

Dimensions (mm) : D180 / H150
 Material : AL 1050 / 1060 / 1070 / 6063
 Finish : Anodized / Clean

Round Series (Dia.100mm ~ 149mm)

FORGED PIN FIN HEATSINKS

JCHAF0001

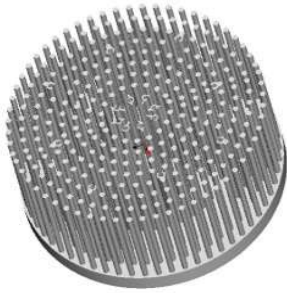

Dimensions (mm) : D143 / H70 / T10
 Material : AL 1050 / 1060 / 1070 / 6063
 Finish : Anodized / Clean

JCHAF0002

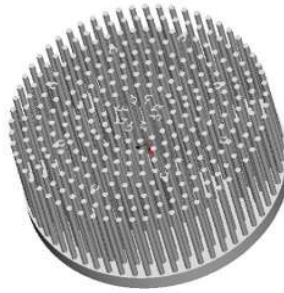

Dimensions (mm) : D140 / H63 / T10
 Material : AL 1050 / 1060 / 1070 / 6063
 Finish : Anodized / Clean

JCHAF0003

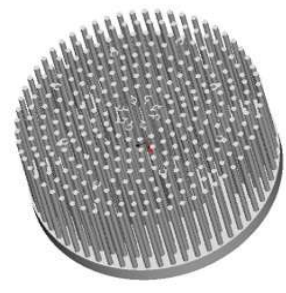

Dimensions (mm) : D130 / H50 / T10
 Material : AL 1050 / 1060 / 1070 / 6063
 Finish : Anodized / Clean

JCHAF0004

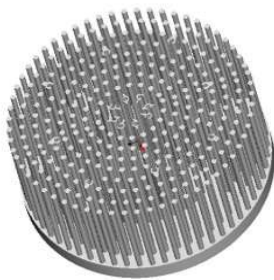

Dimensions (mm) : D125 / H50 / T10
 Material : AL 1050 / 1060 / 1070 / 6063
 Finish : Anodized / Clean

JCHAF0005

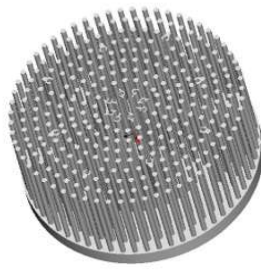

Dimensions (mm) : D110 / H50 / T10
 Material : AL 1050 / 1060 / 1070 / 6063
 Finish : Anodized / Clean

JCHAF0013



Dimensions (mm) : D131 / H50 / T5
 Material : AL 1050 / 1060 / 1070 / 6063
 Finish : Anodized / Clean

JCHAF0014



Dimensions (mm) : D111 / H50 / T5
 Material : AL 1050 / 1060 / 1070 / 6063
 Finish : Anodized / Clean

JCHAF0018

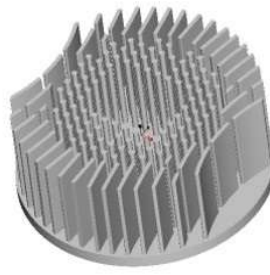

Dimensions (mm) : D126 / H48 / T6
 Material : AL 1050 / 1060 / 1070 / 6063
 Finish : Anodized / Clean

JCHAF0023

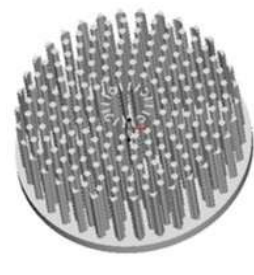

Dimensions (mm) : D105 / H50 / T5
 Material : AL 1050 / 1060 / 1070 / 6063
 Finish : Anodized / Clean

JCHAF0032



Dimensions (mm) : D118.5 / H78 / T9
 Material : AL 1050 / 1060 / 1070 / 6063
 Finish : Anodized / Clean

JCHAF0035



Dimensions (mm) : D133 / H32 / T5
 Material : AL 1050 / 1060 / 1070 / 6063
 Finish : Anodized / Clean

JCHAF0041

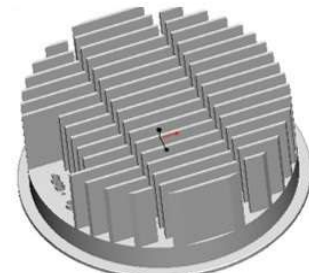

Dimensions (mm) : D143.5 / H80 / T24.9
 Material : AL 1050 / 1060 / 1070 / 6063
 Finish : Anodized / Clean

Round Series (Dia.100mm ~ 149mm)

FORGED PIN FIN HEATSINKS

JCHAF0046



Dimensions (mm) : D144 / H30 / T5
 Material : AL 1050 / 1060 / 1070 / 6063
 Finish : Anodized / Clean

JCHAF0048

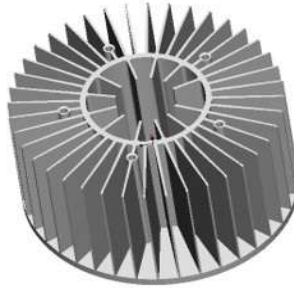

Dimensions (mm) : D140 / H100 / T6
 Material : AL 1050 / 1060 / 1070 / 6063
 Finish : Anodized / Clean

JCHAF0052



Dimensions (mm) : D140 / H90 / T9
 Material : AL 1050 / 1060 / 1070 / 6063
 Finish : Anodized / Clean

JCHAF0059



Dimensions (mm) : D128.5 / H128 / T8
 Material : AL 1050 / 1060 / 1070 / 6063
 Finish : Anodized / Clean

JCHAF0060

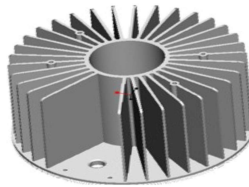

Dimensions (mm) : D128.5 / H46 / T8
 Material : AL 1050 / 1060 / 1070 / 6063
 Finish : Anodized / Clean

JCHAF0064



Dimensions (mm) : D114.3 / H53.87 / T10
 Material : AL 1050 / 1060 / 1070 / 6063
 Finish : Anodized / Clean

JCHAF0065

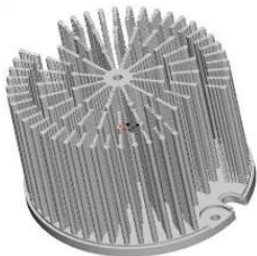

Dimensions (mm) : D123 / H107 / T12
 Material : AL 1050 / 1060 / 1070 / 6063
 Finish : Anodized / Clean

JCHAF0068



Dimensions (mm) : D104.5 / H54.5 / T6.5
 Material : AL 1050 / 1060 / 1070 / 6063
 Finish : Anodized / Clean

JCHAF0072

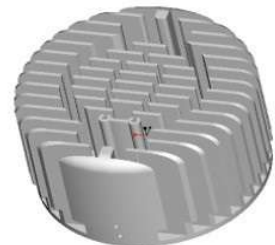

Dimensions (mm) : D120 / H86
 Material : AL 1050 / 1060 / 1070 / 6063
 Finish : Anodized / Clean

JCHAF0077

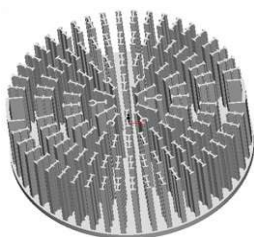

Dimensions (mm) : D138 / H55 / T5
 Material : AL 1050 / 1060 / 1070 / 6063
 Finish : Anodized / Clean

JCHAF0078

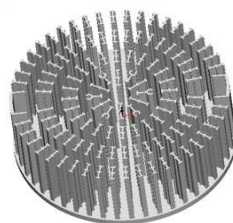

Dimensions (mm) : D110 / H55 / T5
 Material : AL 1050 / 1060 / 1070 / 6063
 Finish : Anodized / Clean

JCHAF0085

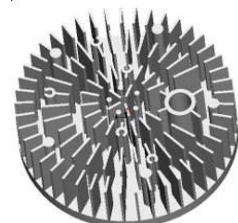

Dimensions (mm) : D102 / H40
 Material : AL 1050 / 1060 / 1070 / 6063
 Finish : Anodized / Clean

Round Series (Dia.50mm ~ 99mm)

FORGED PIN FIN HEATSINKS

JCHAF0096

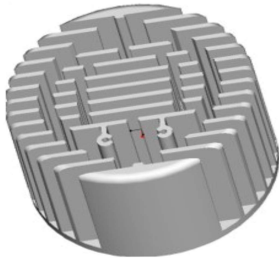

Dimensions (mm) : D130 / H70 / T4
 Material : AL 1050 / 1060 / 1070 / 6063
 Finish : Anodized / Clean

JCHAF0006

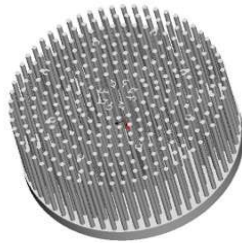

Dimensions (mm) : D96 / H50 / T10
 Material : AL 1050 / 1060 / 1070 / 6063
 Finish : Anodized / Clean

JCHAF0007

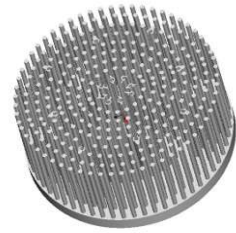

Dimensions (mm) : D85 / H50 / T10
 Material : AL 1050 / 1060 / 1070 / 6063
 Finish : Anodized / Clean

JCHAF0008

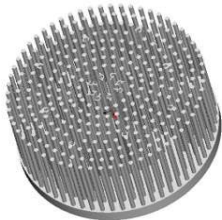

Dimensions (mm) : D70 / H50 / T7
 Material : AL 1050 / 1060 / 1070 / 6063
 Finish : Anodized / Clean

JCHAF0009

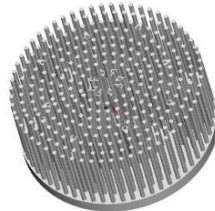

Dimensions (mm) : D60 / H50 / T5
 Material : AL 1050 / 1060 / 1070 / 6063
 Finish : Anodized / Clean

JCHAF0010

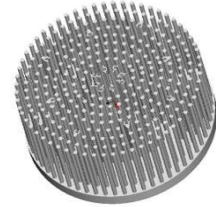

Dimensions (mm) : D50 / H50 / T5
 Material : AL 1050 / 1060 / 1070 / 6063
 Finish : Anodized / Clean

JCHAF0015

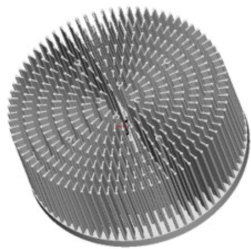

Dimensions (mm) : D91 / H50 / T5
 Material : AL 1050 / 1060 / 1070 / 6063
 Finish : Anodized / Clean

JCHAF0016



Dimensions (mm) : D71 / H50 / T5
 Material : AL 1050 / 1060 / 1070 / 6063
 Finish : Anodized / Clean

JCHAF0017

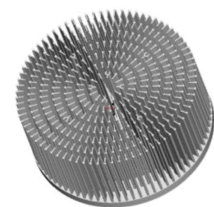

Dimensions (mm) : D51 / H50 / T5
 Material : AL 1050 / 1060 / 1070 / 6063
 Finish : Anodized / Clean

JCHAF0022

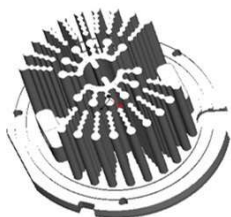

Dimensions (mm) : D73 / H74 / T9
 Material : AL 1050 / 1060 / 1070 / 6063
 Finish : Anodized / Clean

JCHAF0024

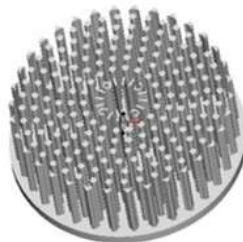

Dimensions (mm) : D97 / H50 / T5
 Material : AL 1050 / 1060 / 1070 / 6063
 Finish : Anodized / Clean

JCHAF0025

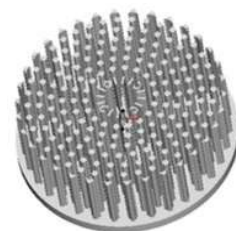

Dimensions (mm) : D88 / H50 / T5
 Material : AL 1050 / 1060 / 1070 / 6063
 Finish : Anodized / Clean

Round Series (Dia.50mm ~ 99mm)

FORGED PIN FIN HEATSINKS

JCHAF0026

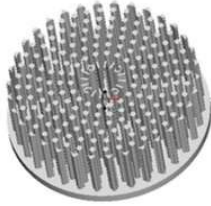

Dimensions (mm) : D77 / H50 / T5
 Material : AL 1050 / 1060 / 1070 / 6063
 Finish : Anodized / Clean

JCHAF0027

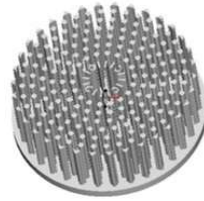

Dimensions (mm) : D66 / H50 / T5
 Material : AL 1050 / 1060 / 1070 / 6063
 Finish : Anodized / Clean

JCHAF0028

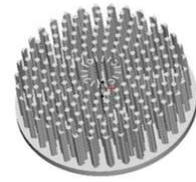

Dimensions (mm) : D55 / H50 / T5
 Material : AL 1050 / 1060 / 1070 / 6063
 Finish : Anodized / Clean

JCHAF0029



Dimensions (mm) : D60.5 / H55 / T23
 Material : AL 1050 / 1060 / 1070 / 6063
 Finish : Anodized / Clean

JCHAF0030

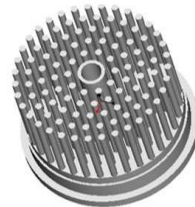

Dimensions (mm) : D52 / H55 / T23
 Material : AL 1050 / 1060 / 1070 / 6063
 Finish : Anodized / Clean

JCHAF0031

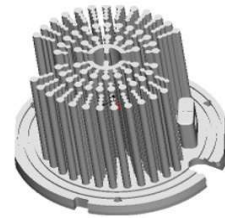

Dimensions (mm) : D82 / H84.5 / T9
 Material : AL 1050 / 1060 / 1070 / 6063
 Finish : Anodized / Clean

JCHAF0033



Dimensions (mm) : D64.5 / H55 / T5
 Material : AL 1050 / 1060 / 1070 / 6063
 Finish : Anodized / Clean

JCHAF0034

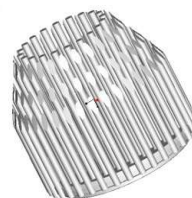

Dimensions (mm) : D71 / H43.4 / T7
 Material : AL 1050 / 1060 / 1070 / 6063
 Finish : Anodized / Clean

JCHAF0040



Dimensions (mm) : D81 / H62 / T5
 Material : AL 1050 / 1060 / 1070 / 6063
 Finish : Anodized / Clean

JCHAF0042

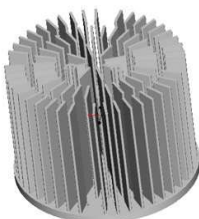

Dimensions (mm) : D80 / H70 / T5
 Material : AL 1050 / 1060 / 1070 / 6063
 Finish : Anodized / Clean

JCHAF0043



Dimensions (mm) : D50 / H33 / T2.2
 Material : AL 1050 / 1060 / 1070 / 6063
 Finish : Anodized / Clean

JCHAF0050

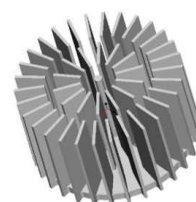

Dimensions (mm) : D66 / H40 / T3.5
 Material : AL 1050 / 1060 / 1070 / 6063
 Finish : Anodized / Clean

Round Series (Dia.50mm ~ 99mm)

FORGED PIN FIN HEATSINKS

JCHAF0057



Dimensions (mm) : D62 / H75 / T5
 Material : AL 1050 / 1060 / 1070 / 6063
 Finish : Anodized / Clean

JCHAF0058

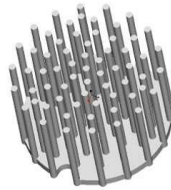

Dimensions (mm) : D62.3 / H40 / T3.5
 Material : AL 1050 / 1060 / 1070 / 6063
 Finish : Anodized / Clean

JCHAF0061

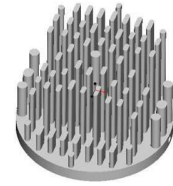

Dimensions (mm) : D63 / H40 / T6
 Material : AL 1050 / 1060 / 1070 / 6063
 Finish : Anodized / Clean

JCHAF0066

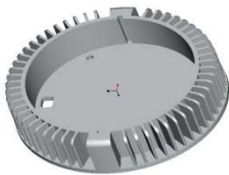

Dimensions (mm) : D90 / H26 / T6
 Material : AL 1050 / 1060 / 1070 / 6063
 Finish : Anodized / Clean

JCHAF0067

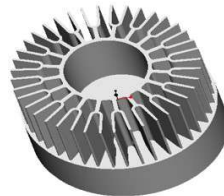

Dimensions (mm) : D70 / H63 / T28
 Material : AL 1050 / 1060 / 1070 / 6063
 Finish : Anodized / Clean

JCHAF0069

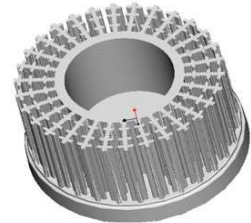

Dimensions (mm) : D95 / H62 / T15
 Material : AL 1050 / 1060 / 1070 / 6063
 Finish : Anodized / Clean

JCHAF0070



Dimensions (mm) : D90.6 / H92
 Material : AL 1050 / 1060 / 1070 / 6063
 Finish : Anodized / Clean

JCHAF0071



Dimensions (mm) : D94.6 / H68
 Material : AL 1050 / 1060 / 1070 / 6063
 Finish : Anodized / Clean

JCHAF0074

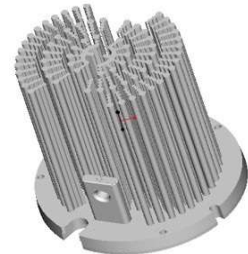

Dimensions (mm) : D88.5 / H94 / T9
 Material : AL 1050 / 1060 / 1070 / 6063
 Finish : Anodized / Clean

JCHAF0084

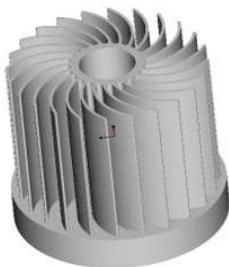

Dimensions (mm) : D99 / H95 / T18.5
 Material : AL 1050 / 1060 / 1070 / 6063
 Finish : Anodized / Clean

JCHAF0086

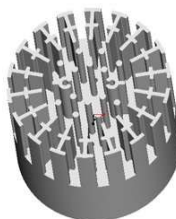

Dimensions (mm) : D63 / H47
 Material : AL 1050 / 1060 / 1070 / 6063
 Finish : Anodized / Clean

JCHAF0087

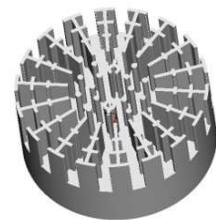

Dimensions (mm) : D80 / H47
 Material : AL 1050 / 1060 / 1070 / 6063
 Finish : Anodized / Clean

Round Series (Dia.50mm ~ 99mm)
Round Series (Dia.49mm ↓)



FORGED PIN FIN HEATSINKS

JCHAF0088

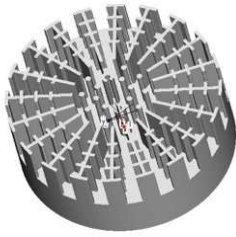

Dimensions (mm) : D96 / H47
 Material : AL 1050 / 1060 / 1070 / 6063
 Finish : Anodized / Clean

JCHAF0089

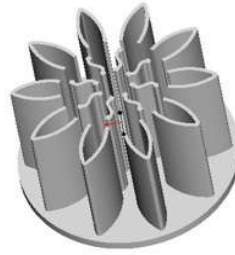

Dimensions (mm) : D94 / H55
 Material : AL 1050 / 1060 / 1070 / 6063
 Finish : Anodized / Clean

JCHAF0090

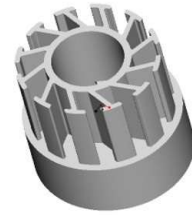

Dimensions (mm) : D55 / H60
 Material : AL 1050 / 1060 / 1070 / 6063
 Finish : Anodized / Clean

JCHAF0092

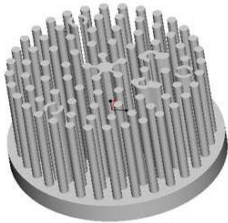

Dimensions (mm) : D83 / H55 / T10
 Material : AL 1050 / 1060 / 1070 / 6063
 Finish : Anodized / Clean

JCHAF0095

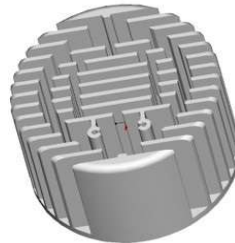

Dimensions (mm) : D96 / H60 / T4
 Material : AL 1050 / 1060 / 1070 / 6063
 Finish : Anodized / Clean

JCHAF0098



Dimensions (mm) : D73.6 / H63.5 / T5
 Material : AL 1050 / 1060 / 1070 / 6063
 Finish : Anodized / Clean

JCHAF0069

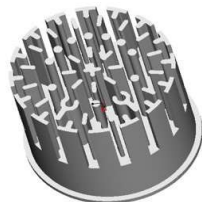

Dimensions (mm) : D49.8 / H48 / T24.5
 Material : AL 1050 / 1060 / 1070 / 6063
 Finish : Anodized / Clean

JCHAF0020



Dimensions (mm) : D49.5 / H31.2 / T2.2
 Material : AL 1050 / 1060 / 1070 / 6063
 Finish : Anodized / Clean

JCHAF0063



Dimensions (mm) : D49.8 / H24.5
 Material : AL 1050 / 1060 / 1070 / 6063
 Finish : Anodized / Clean

JCHAF0075



Dimensions (mm) : D31.9 / H25 / T3
 Material : AL 1050 / 1060 / 1070 / 6063
 Finish : Anodized / Clean

JCHAF0083



Dimensions (mm) : D39.6 / H47
 Material : AL 1050 / 1060 / 1070 / 6063
 Finish : Anodized / Clean

JCHAF0099



Dimensions (mm) : D47 / H49
 Material : AL 1050 / 1060 / 1070 / 6063
 Finish : Anodized / Clean

Quadrilateral Series

FORGED PIN FIN HEATSINKS

JCHAF0021

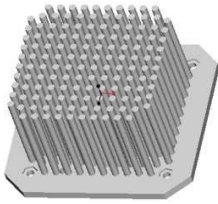

Dimensions (mm) : L82 / W82 / H48.5 / T5
 Material : AL 1050 / 1060 / 1070 / 6063
 Finish : Anodized / Clean

JCHAF0037

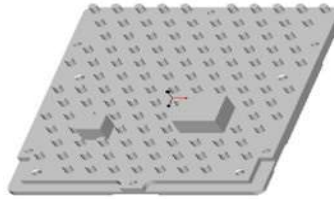

Dimensions (mm) : L136 / W111.6 / H25.5 / T12.5
 Material : AL 1050 / 1060 / 1070 / 6063
 Finish : Anodized / Clean

JCHAF0038

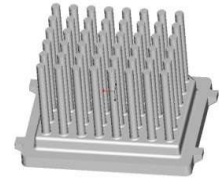

Dimensions (mm) : L69 / W48.6 / H39.5
 Material : AL 1050 / 1060 / 1070 / 6063
 Finish : Anodized / Clean

JCHAF0039

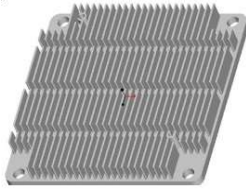

Dimensions (mm) : L87 / W87 / H13.5 / T6
 Material : AL 1050 / 1060 / 1070 / 6063
 Finish : Anodized / Clean

JCHAF0049

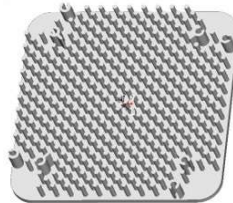

Dimensions (mm) : L90 / W90 / H16 / T6.2
 Material : AL 1050 / 1060 / 1070 / 6063
 Finish : Anodized / Clean

JCHAF0051



Dimensions (mm) : L79 / W61.3 / H35 / T5
 Material : AL 1050 / 1060 / 1070 / 6063
 Finish : Anodized / Clean

JCHAF0055

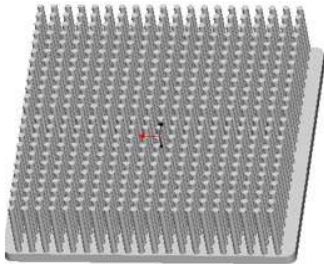

Dimensions (mm) : L150 / W150 / H45 / T7
 Material : AL 1050 / 1060 / 1070 / 6063
 Finish : Anodized / Clean

JCHAF0056

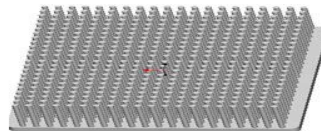

Dimensions (mm) : L150 / W75 / H60 / T7
 Material : AL 1050 / 1060 / 1070 / 6063
 Finish : Anodized / Clean

JCHAF0062



Dimensions (mm) : L25.4 / W25.4 / H12.73 / T1.5
 Material : AL 1050 / 1060 / 1070 / 6063
 Finish : Anodized / Clean

JCHAF0091

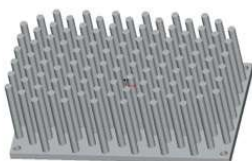

Dimensions (mm) : L101.6 / W61 / H38
 Material : AL 1050 / 1060 / 1070 / 6063
 Finish : Anodized / Clean

JCHAF0097

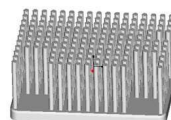

Dimensions (mm) : L60 / W40 / H18
 Material : AL 1050 / 1060 / 1070 / 6063
 Finish : Anodized / Clean

JCHAC00003



Dimensions (mm) : L105.6 / W59.6 / H8.7 / T2.5
 Material : CU1100
 Finish : Anti-oxidation

Extruded heatsink with solder pins



JBHAE5251

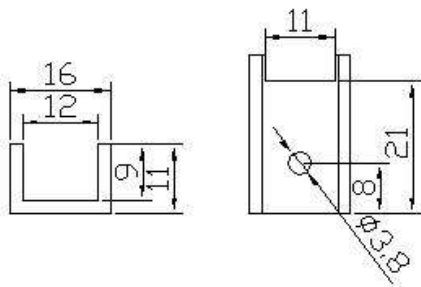

Dimensions (mm) : L21 / W16 / H11
 Material : AL 6063-T5
 Finish / Color : Anodized Black

JBHAE5252

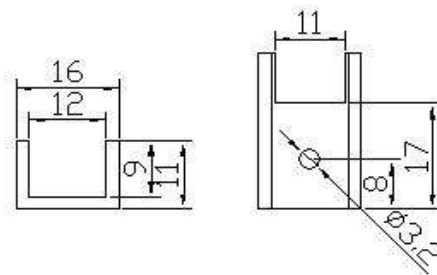

Dimensions (mm) : L17 / W16 / H11
 Material : AL 6063-T5
 Finish / Color : Anodized Black

JBHAE5253

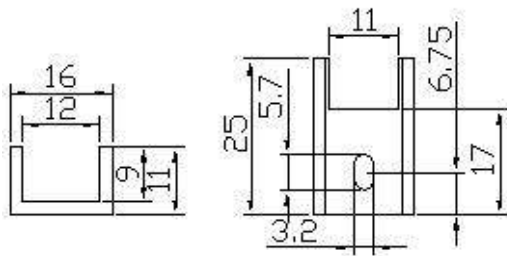

Dimensions (mm) : L25 / W16 / H11
 Material : AL 6063-T5
 Finish / Color : Anodized Black

JBHAE5301

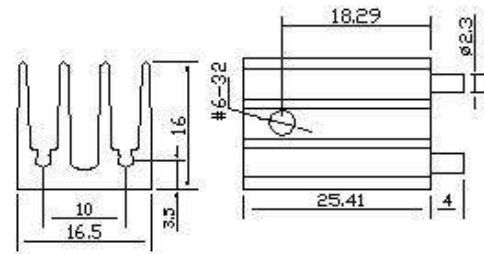

Dimensions (mm) : L25.4 / W16.5 / H16
 Material : AL 6063-T5
 Finish / Color : Anodized Black

JBHAE5302

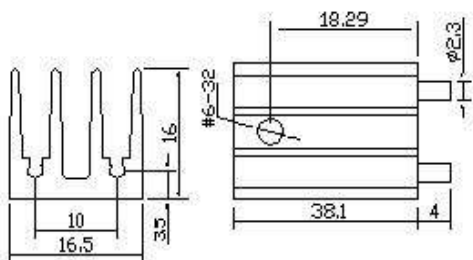

Dimensions (mm) : L38.1 / W16.5 / H16
 Material : AL 6063-T5
 Finish / Color : Anodized Black

JBHAE5303

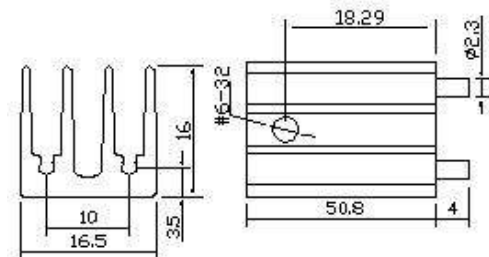

Dimensions (mm) : L50.8 / W16.5 / H16
 Material : AL 6063-T5
 Finish / Color : Anodized Black

PCB Mount Series

EXTRUDED HEATSINKS

JBHAE0352

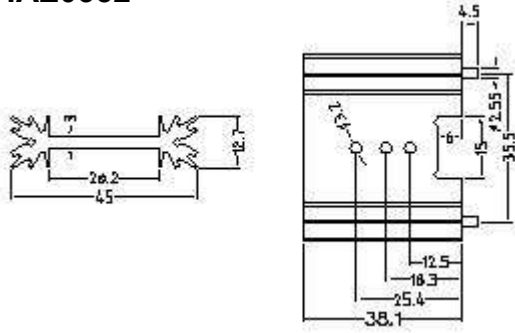

Dimensions (mm) : L38.1 / W45 / H12.7
 Material : AL 6063-T5
 Finish / Color : Anodized Black

JBHAE0353

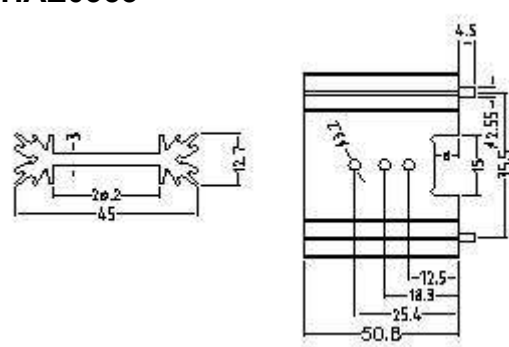

Dimensions (mm) : L50.8 / W45 / H12.7
 Material : AL 6063-T5
 Finish / Color : Anodized Black

JBHAE0354

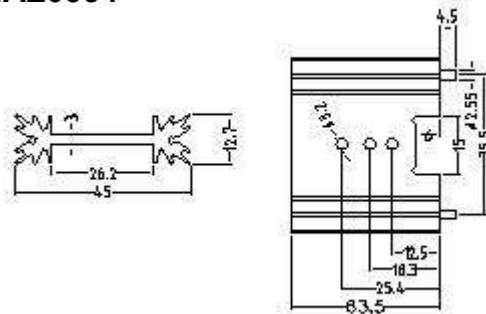

Dimensions (mm) : L63.5 / W45 / H12.7
 Material : AL 6063-T5
 Finish / Color : Anodized Black

JBHAE0361

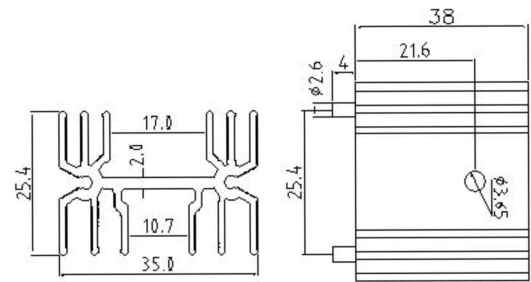

Dimensions (mm) : L38 / W35 / H25.4
 Material : AL 6063-T5
 Finish / Color : Anodized Black

JBHAE0362

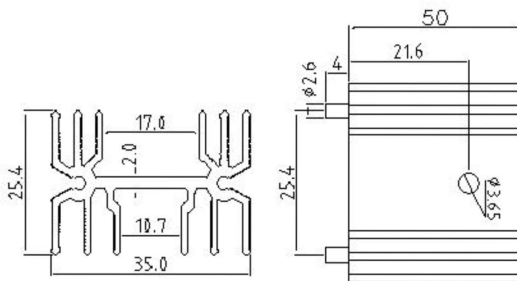

Dimensions (mm) : L50 / W35 / H25.4
 Material : AL 6063-T5
 Finish / Color : Anodized Black

JBHAE0363

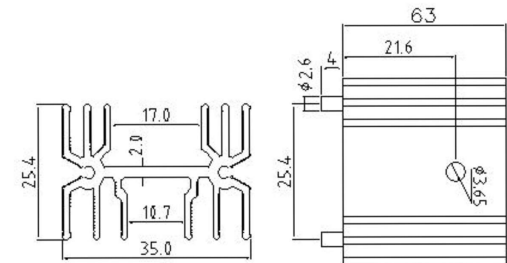

Dimensions (mm) : L63 / W35 / H25.4
 Material : AL 6063-T5
 Finish / Color : Anodized Black

JBHAE8011

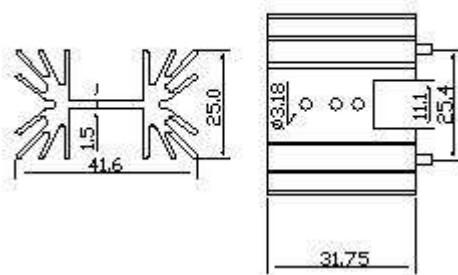

Dimensions (mm) : L31.75 / W41.6 / H25
 Material : AL 6063-T5
 Finish / Color : Anodized Black

JBHAE8012

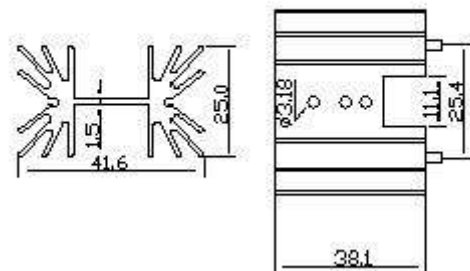

Dimensions (mm) : L38.1 / W41.6 / H25
 Material : AL 6063-T5
 Finish / Color : Anodized Black

PCB Mount Series

EXTRUDED HEATSINKS

JBHAE8013

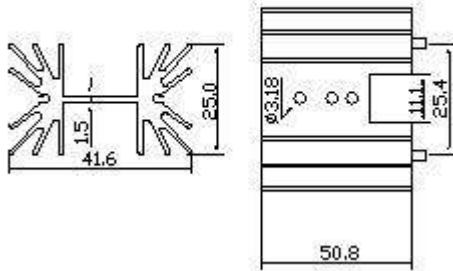

Dimensions (mm) : L50.8 / W41.6 / H25
 Material : AL 6063-T5
 Finish / Color : Anodized Black

JBHAE8014

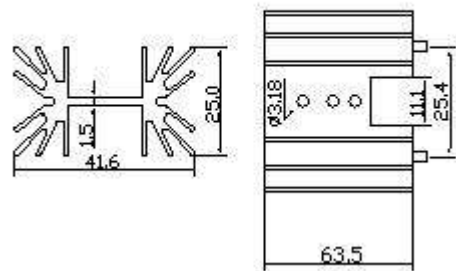

Dimensions (mm) : L63.5 / W41.6 / H25
 Material : AL 6063-T5
 Finish / Color : Anodized Black

JBHAE8016

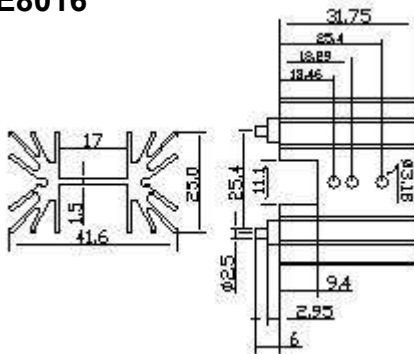

Dimensions (mm) : L31.75 / W41.6 / H25
 Material : AL 6063-T5
 Finish / Color : Anodized Black

JBHAE8017

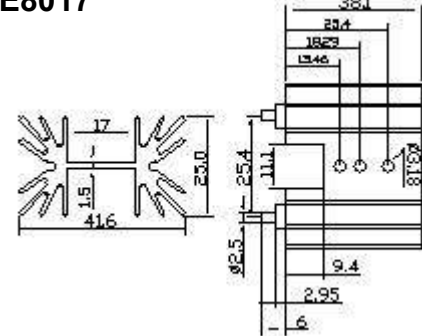

Dimensions (mm) : L38.1 / W41.6 / H25
 Material : AL 6063-T5
 Finish / Color : Anodized Black

JBHAE8018

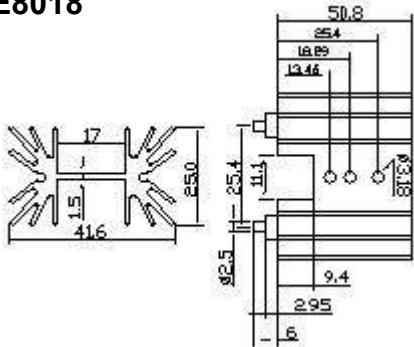

Dimensions (mm) : L50.8 / W41.6 / H25
 Material : AL 6063-T5
 Finish / Color : Anodized Black

JBHAE8019

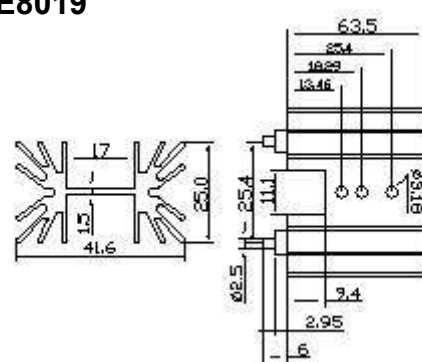

Dimensions (mm) : L63.5 / W41.6 / H25
 Material : AL 6063-T5
 Finish / Color : Anodized Black

JBHAE8041

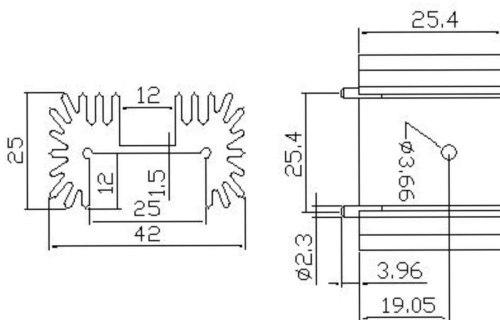

Dimensions (mm) : L25.4 / W42 / H25
 Material : AL 6063-T5
 Finish / Color : Anodized Black

JBHAE8042

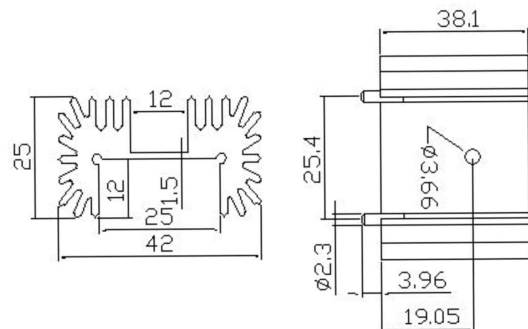

Dimensions (mm) : L38.1 / W42 / H25
 Material : AL 6063-T5
 Finish / Color : Anodized Black

PCB Mount Series

EXTRUDED HEATSINKS

JBHAE8043

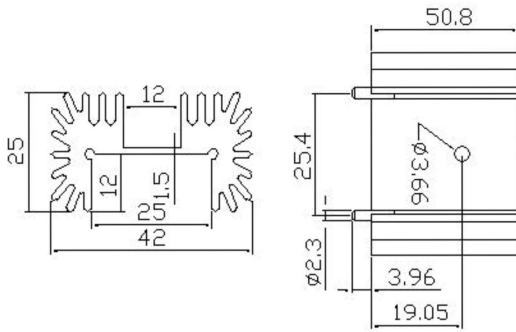

Dimensions (mm) : L50.8 / W42 / H25
 Material : AL 6063-T5
 Finish / Color : Anodized Black

JBHAE8044

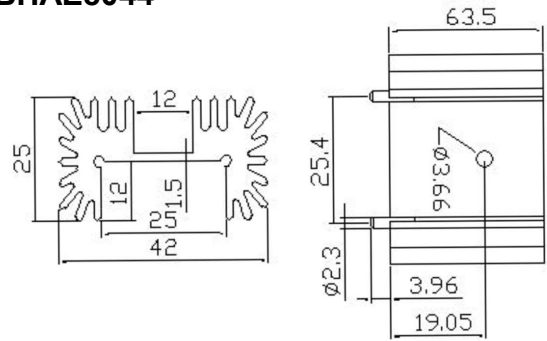

Dimensions (mm) : L63.5 / W42 / H25
 Material : AL 6063-T5
 Finish / Color : Anodized Black

JBHAE8045

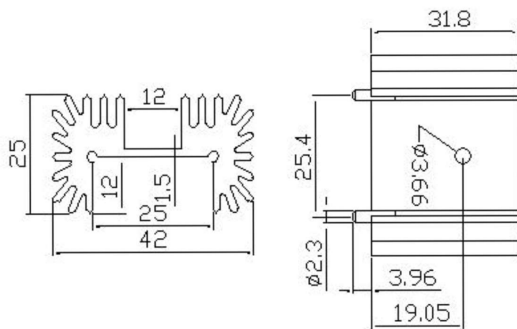

Dimensions (mm) : L31.8 / W42 / H25
 Material : AL 6063-T5
 Finish / Color : Anodized Black

JBHAE8110

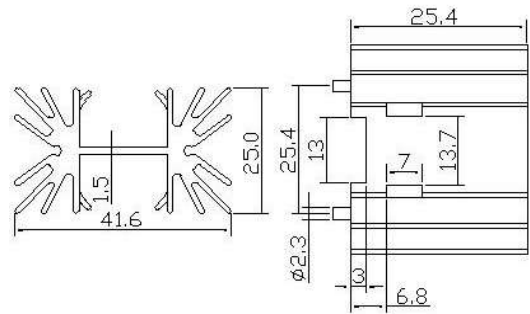

Dimensions (mm) : L25.4 / W41.6 / H25
 Material : AL 6063-T5
 Finish / Color : Anodized Black

JBHAE8111

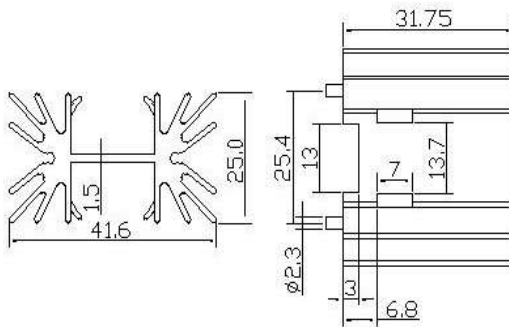

Dimensions (mm) : L31.75 / W41.6 / H25
 Material : AL 6063-T5
 Finish / Color : Anodized Black

JBHAE8112

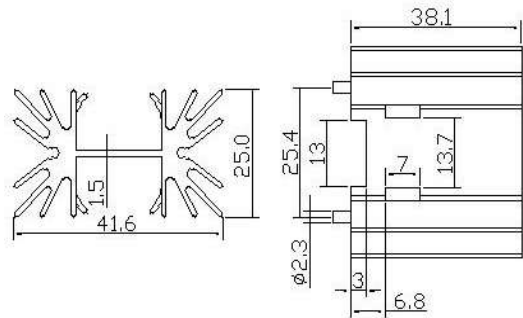

Dimensions (mm) : L38.1 / W41.6 / H25
 Material : AL 6063-T5
 Finish / Color : Anodized Black

JBHAE8113

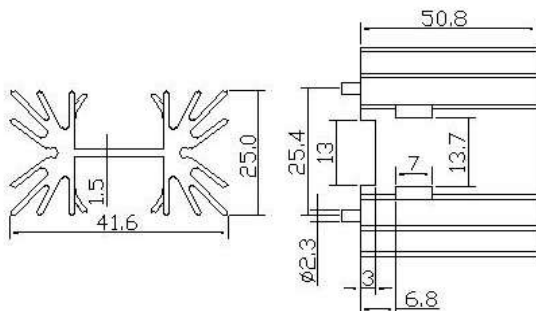

Dimensions (mm) : L50.8 / W41.6 / H25
 Material : AL 6063-T5
 Finish / Color : Anodized Black

JBHAE8114

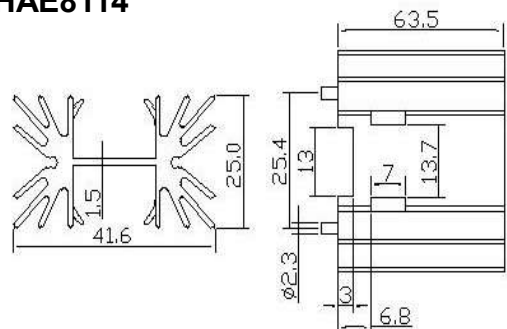

Dimensions (mm) : L63.5 / W41.6 / H25
 Material : AL 6063-T5
 Finish / Color : Anodized Black

JBHAE2012

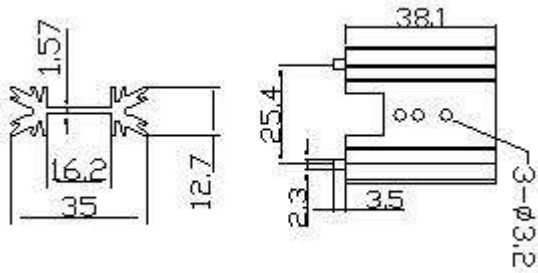

Dimensions (mm) : L38.1 / W35 / H12.7
 Material : AL 6063-T5
 Finish / Color : Anodized Black

JBHAE2013

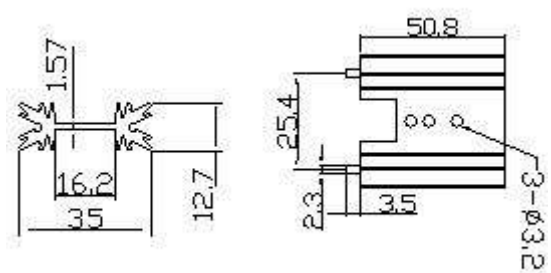

Dimensions (mm) : L50.8 / W35 / H12.7
 Material : AL 6063-T5
 Finish / Color : Anodized Black

JBHAE2014

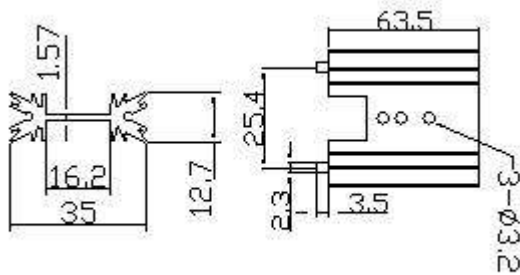

Dimensions (mm) : L63.5 / W35 / H12.7
 Material : AL 6063-T5
 Finish / Color : Anodized Black

JBHAE2015

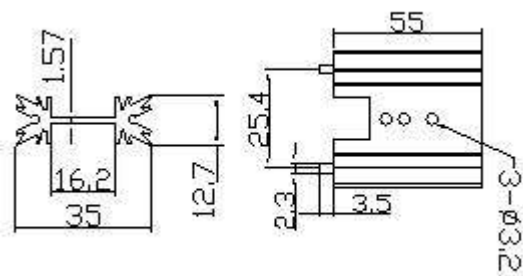

Dimensions (mm) : L55 / W35 / H12.7
 Material : AL 6063-T5
 Finish / Color : Anodized Black

JBHAE2082

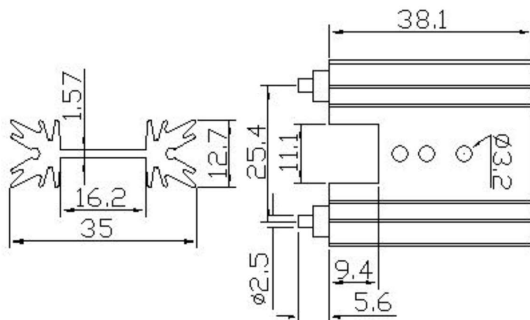

Dimensions (mm) : L38.1 / W35 / H12.7
 Material : AL 6063-T5
 Finish / Color : Anodized Black

JBHAE2083

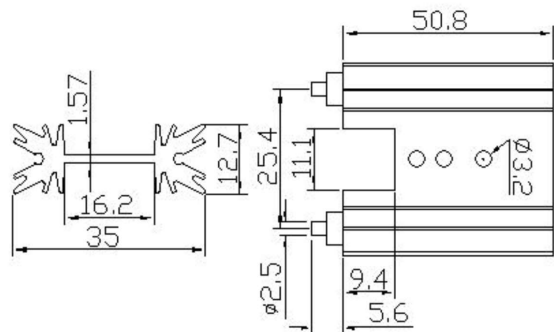

Dimensions (mm) : L50.8 / W35 / H12.7
 Material : AL 6063-T5
 Finish / Color : Anodized Black

JBHAE2084

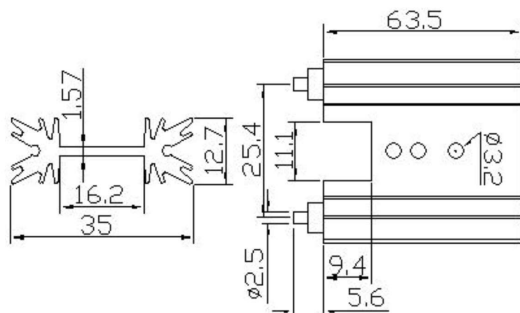

Dimensions (mm) : L63.5 / W35 / H12.7
 Material : AL 6063-T5
 Finish / Color : Anodized Black

JBHAE2510

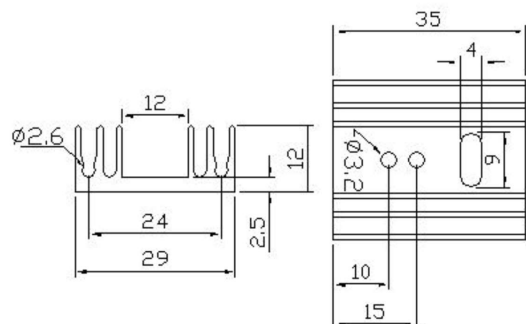

Dimensions (mm) : L35 / W29 / H12
 Material : AL 6063-T5
 Finish / Color : Anodized Black

PCB Mount Series

EXTRUDED HEATSINKS

JBHAE2091

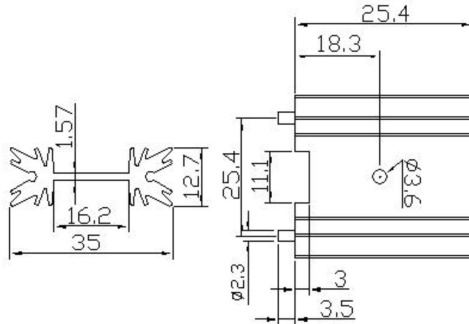

Dimensions (mm) : L24.5 / W35 / H12.7
 Material : AL 6063-T5
 Finish / Color : Anodized Black

JBHAE2092

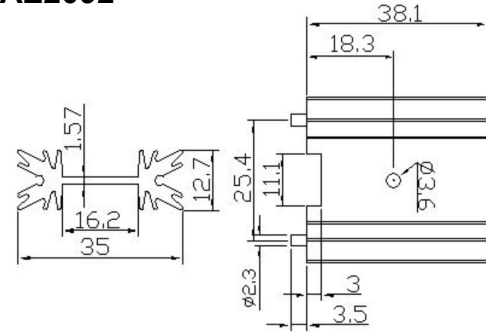

Dimensions (mm) : L38.1 / W35 / H12.7
 Material : AL 6063-T5
 Finish / Color : Anodized Black

JBHAE2142

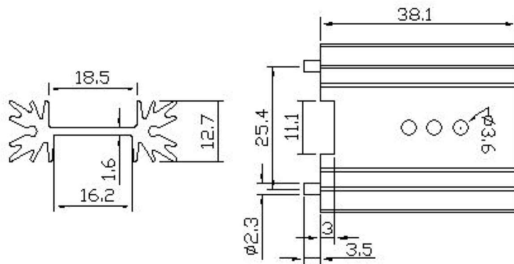

Dimensions (mm) : L38.1 / W35 / H12.7
 Material : AL 6063-T5
 Finish / Color : Anodized Black

JBHAE2143

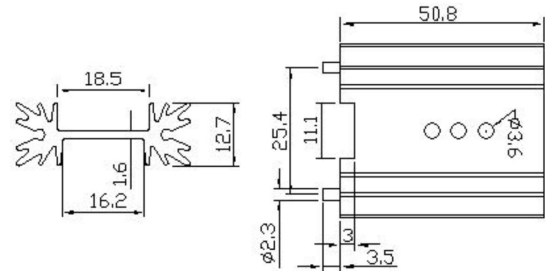

Dimensions (mm) : L50.8 / W35 / H12.7
 Material : AL 6063-T5
 Finish / Color : Anodized Black

JBHAE2146

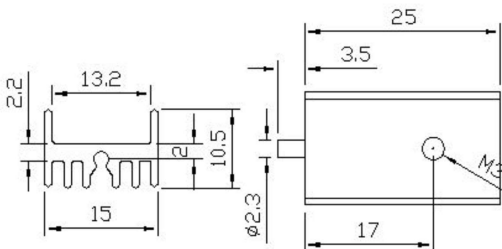

Dimensions (mm) : L25 / W15 / H10.5
 Material : AL 6063-T5
 Finish / Color : Anodized Black

JBHAE2147

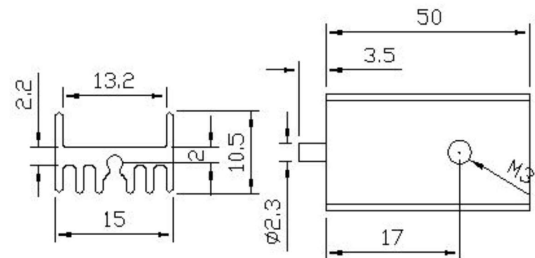

Dimensions (mm) : L50 / W15 / H10.5
 Material : AL 6063-T5
 Finish / Color : Anodized Black

JBHAE2872

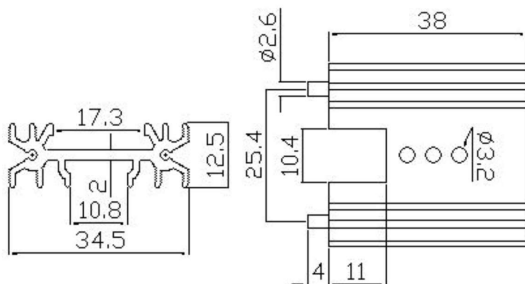

Dimensions (mm) : L38 / W35 / H12.5
 Material : AL 6063-T5
 Finish / Color : Anodized Black

JBHAE2873

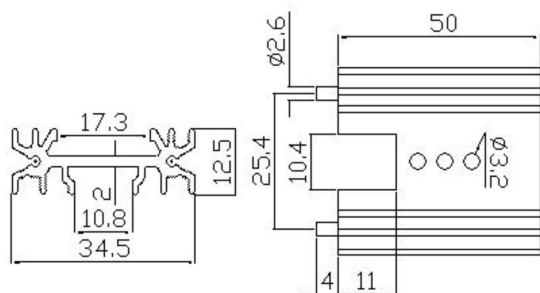

Dimensions (mm) : L50 / W35 / H12.5
 Material : AL 6063-T5
 Finish / Color : Anodized Black

BGA Series

EXTRUDED HEATSINKS

BGA Heatsink can be attached to devices with adhesive thermal tape.

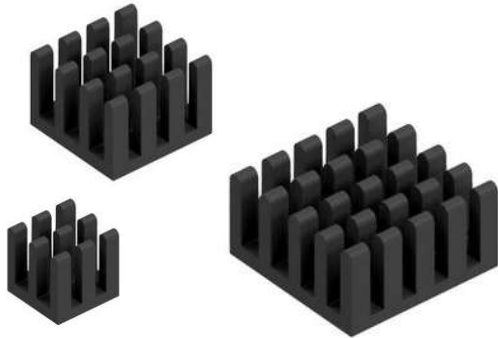

JBHAE0801

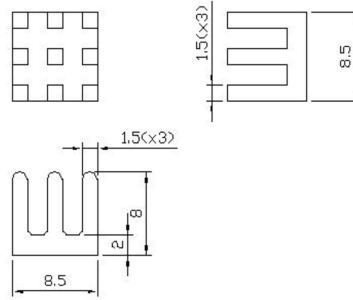

Dimensions (mm) : L8 / W8 / H8
 Material : AL 6063-T5
 Finish / Color : Anodized Black

JBHAE1002

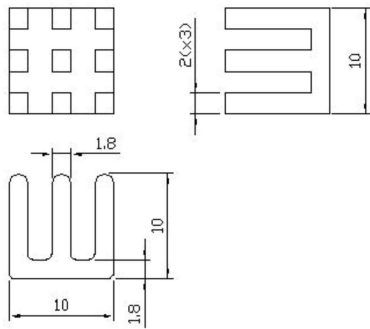

Dimensions (mm) : L10 / W10 / H10
 Material : AL 6063-T5
 Finish / Color : Anodized Black

JBHAE1201

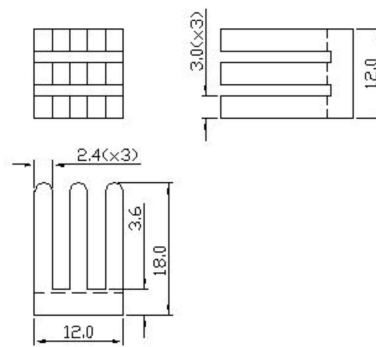

Dimensions (mm) : L12 / W12 / H18
 Material : AL 6063-T5
 Finish / Color : Anodized Black

JBHAE1401

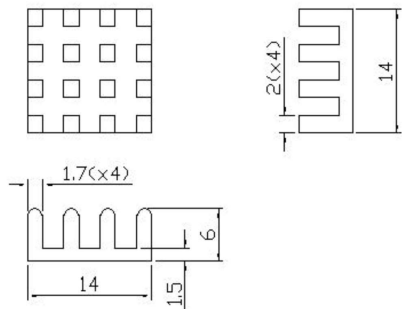

Dimensions (mm) : L14 / W14 / H6
 Material : AL 6063-T5
 Finish / Color : Anodized Black

JBHAE1501

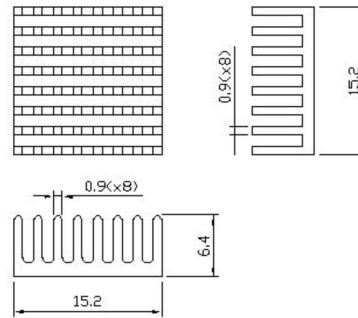

Dimensions (mm) : L15.2 / W15.2 / H6.4
 Material : AL 6063-T5
 Finish / Color : Anodized Black

JBHAE1701

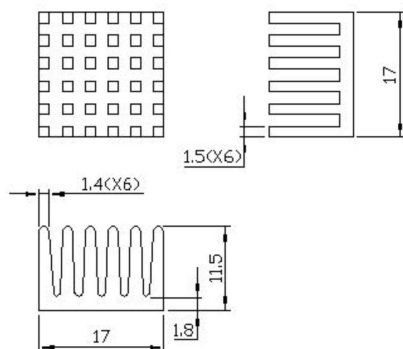

Dimensions (mm) : L17 / W17 / H11.5
 Material : AL 6063-T5
 Finish / Color : Anodized Black

JBHAE1801

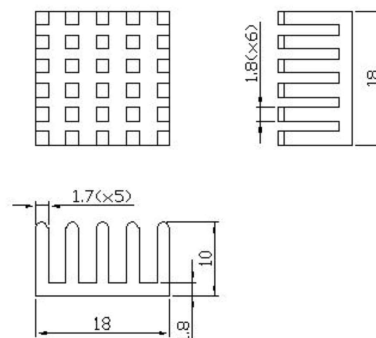

Dimensions (mm) : L18 / W18 / H10
 Material : AL 6063-T5
 Finish / Color : Anodized Black

BGA Series

EXTRUDED HEATSINKS

JBHAE2001

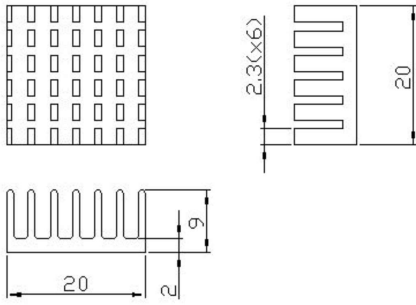

Dimensions (mm) : L20 / W20 / H9
 Material : AL 6063-T5
 Finish / Color : Anodized Black

JBHAE2101

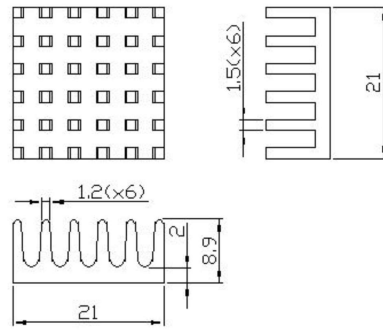

Dimensions (mm) : L21 / W21 / H8.9
 Material : AL 6063-T5
 Finish / Color : Anodized Black

JBHAE2302

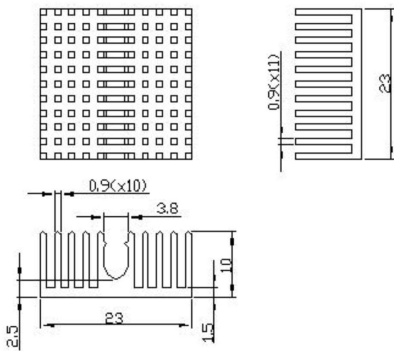

Dimensions (mm) : L23 / W23 / H10
 Material : AL 6063-T5
 Finish / Color : Anodized Black

JBHAE2304

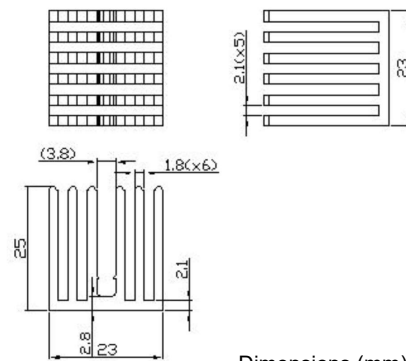

Dimensions (mm) : L23 / W23 / H25
 Material : AL 6063-T5
 Finish / Color : Anodized Black

JBHAE2701

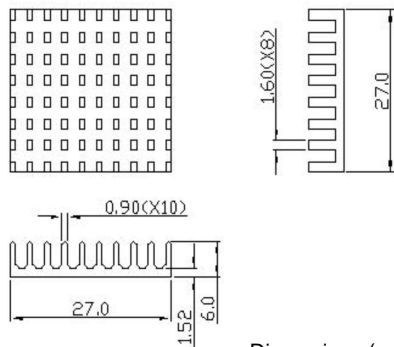

Dimensions (mm) : L27 / W27 / H6
 Material : AL 6063-T5
 Finish / Color : Anodized Black

JBHAE2704

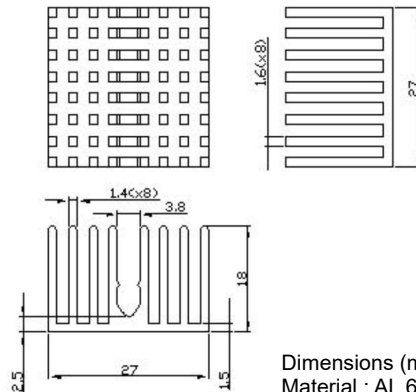

Dimensions (mm) : L27 / W27 / H18
 Material : AL 6063-T5
 Finish / Color : Anodized Black

JBHAE3001

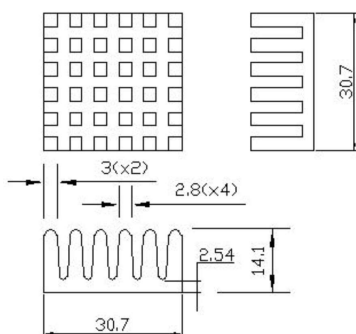

Dimensions (mm) : L30.7 / W30.7 / H14.1
 Material : AL 6063-T5
 Finish / Color : Anodized Black

JBHAE3503

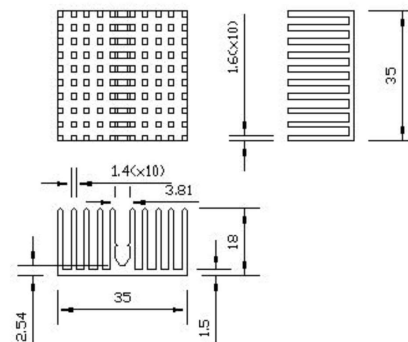

Dimensions (mm) : L35 / W35 / H18
 Material : AL 6063-T5
 Finish / Color : Anodized Black

Extruded Profiles

FEATURES :

- Manufactured by pushing hot aluminum material into a steel mold to form the final shape.
- The most commonly used aluminum alloy is 6063-T5.
- When extruding the material, the maximum length of the initial product is 900cm.
- The initial product is cut to final length, which can then be machined (holes, slots or other secondary operations)..
- The surface treatment is anodized or chromated to improve its thermal properties and provide some corrosion protection.

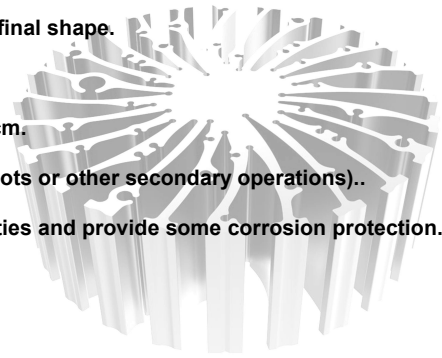

JWHAE0002

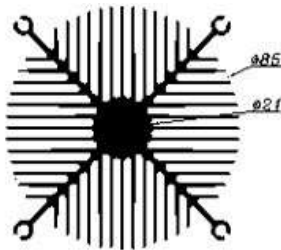

Dimensions (mm) : D85
Material : AL 6063-T5
Finish : Anodized / Clean

JWHAE0005

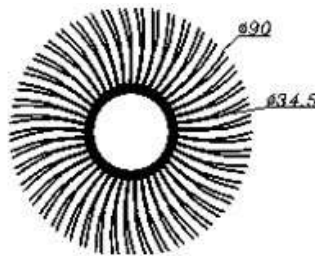

Dimensions (mm) : D90
Material : AL 6063-T5
Finish : Anodized / Clean

JWHAE00010

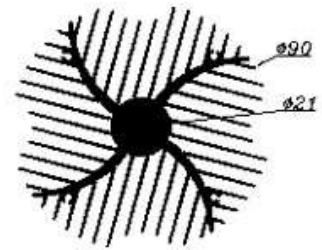

Dimensions (mm) : D90
Material : AL 6063-T5
Finish : Anodized / Clean

JWHAE00012

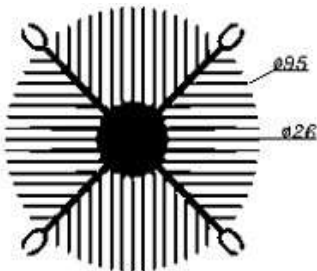

Dimensions (mm) : D95
Material : AL 6063-T5
Finish : Anodized / Clean

JWHAE00017

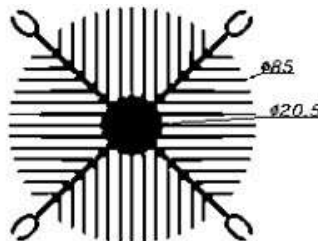

Dimensions (mm) : D85
Material : AL 6063-T5
Finish : Anodized / Clean

JWHAE00021

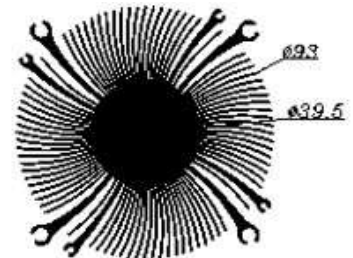

Dimensions (mm) : D93
Material : AL 6063-T5
Finish : Anodized / Clean

JWHAE00027

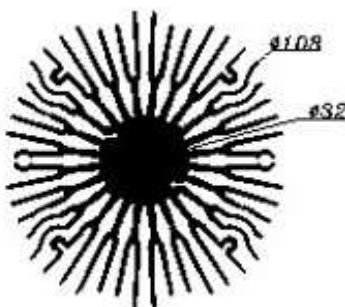

Dimensions (mm) : D108
Material : AL 6063-T5
Finish : Anodized / Clean

JWHAE00037

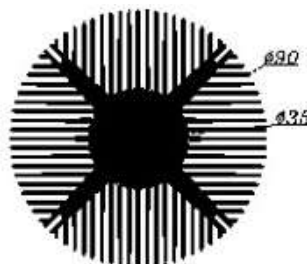

Dimensions (mm) : D90
Material : AL 6063-T5
Finish : Anodized / Clean

JWHAE00095

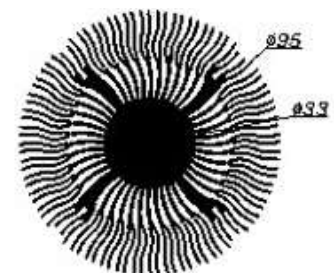

Dimensions (mm) : D95
Material : AL 6063-T5
Finish : Anodized / Clean

Extruded Profiles

EXTRUDED HEATSINKS

JWHAE0009

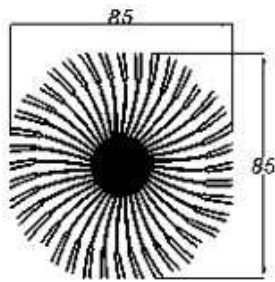

Dimensions (mm) : L85 / W85
Material : AL 6063-T5
Finish : Anodized / Clean

JWHAE0013

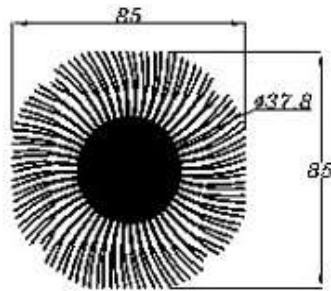

Dimensions (mm) : L85 / W85
Material : AL 6063-T5
Finish : Anodized / Clean

JWHAE0014

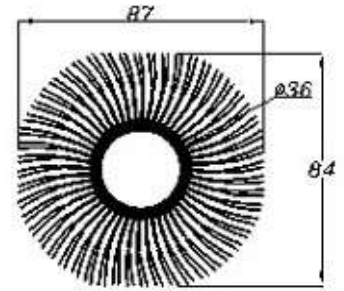

Dimensions (mm) : L87 / W84
Material : AL 6063-T5
Finish : Anodized / Clean

JWHAE0016

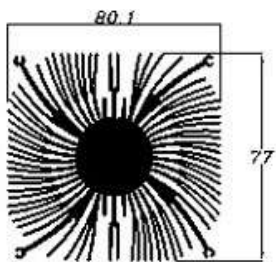

Dimensions (mm) : L80.1 / W77
Material : AL 6063-T5
Finish : Anodized / Clean

JWHAE0018

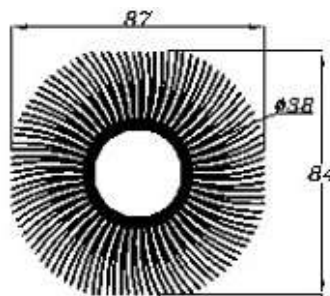

Dimensions (mm) : L87 / W84
Material : AL 6063-T5
Finish : Anodized / Clean

JWHAE0020

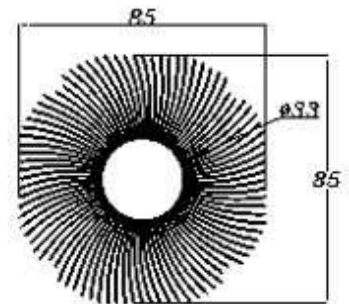

Dimensions (mm) : L85 / W85
Material : AL 6063-T5
Finish : Anodized / Clean

JWHAE0026

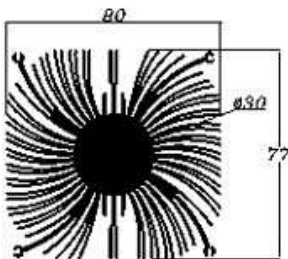

Dimensions (mm) : L80 / W77
Material : AL 6063-T5
Finish : Anodized / Clean

JWHAE0041

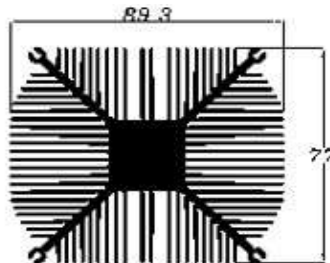

Dimensions (mm) : L89.3 / W77
Material : AL 6063-T5
Finish : Anodized / Clean

JWHAE0042

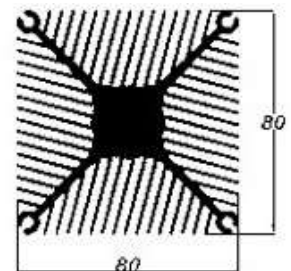

Dimensions (mm) : L80 / W80
Material : AL 6063-T5
Finish : Anodized / Clean

JWHAE0045

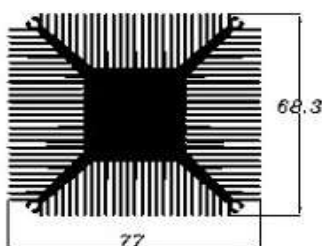

Dimensions (mm) : L77 / W68.3
Material : AL 6063-T5
Finish : Anodized / Clean

JWHAE0046

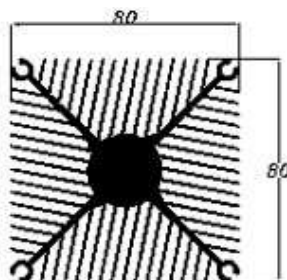

Dimensions (mm) : L80 / W80
Material : AL 6063-T5
Finish : Anodized / Clean

JWHAE0047

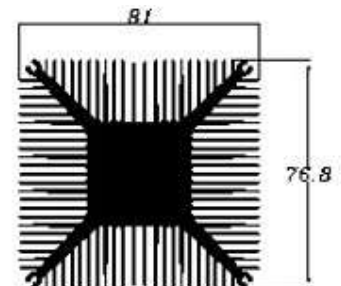

Dimensions (mm) : L81 / W76.8
Material : AL 6063-T5
Finish : Anodized / Clean

Extruded Profiles

EXTRUDED HEATSINKS

JWHAE0049

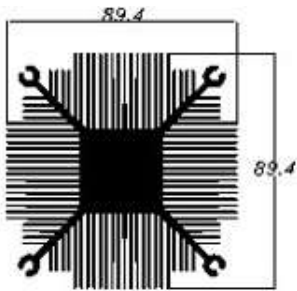

Dimensions (mm) : L89.4 / W89.4
 Material : AL 6063-T5
 Finish : Anodized / Clean

JWHAE0050

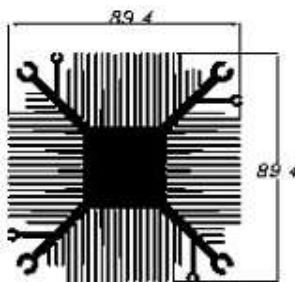

Dimensions (mm) : L89.4 / W89.4
 Material : AL 6063-T5
 Finish : Anodized / Clean

JWHAE0051

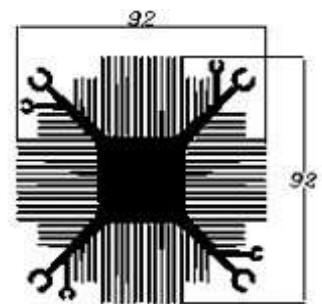

Dimensions (mm) : L92 / W92
 Material : AL 6063-T5
 Finish : Anodized / Clean

JWHAE0052

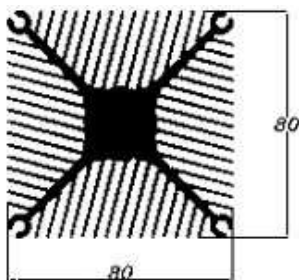

Dimensions (mm) : L80 / W80
 Material : AL 6063-T5
 Finish : Anodized / Clean

JWHAE0053

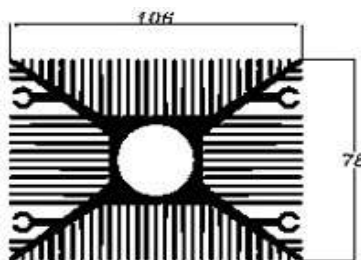

Dimensions (mm) : L106 / W78
 Material : AL 6063-T5
 Finish : Anodized / Clean

JWHAE0056

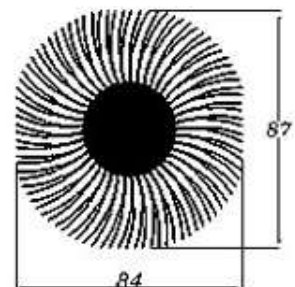

Dimensions (mm) : L87 / W84
 Material : AL 6063-T5
 Finish : Anodized / Clean

JWHAE0057

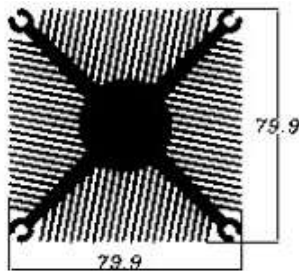

Dimensions (mm) : L79.9 / W79.9
 Material : AL 6063-T5
 Finish : Anodized / Clean

JWHAE0061

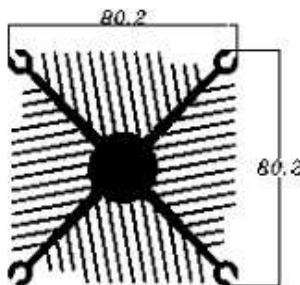

Dimensions (mm) : L80.2 / W80.2
 Material : AL 6063-T5
 Finish : Anodized / Clean

JWHAE0062

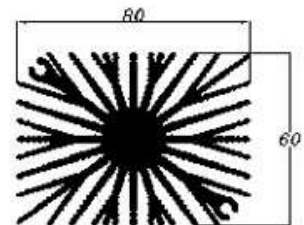

Dimensions (mm) : L80 / W60
 Material : AL 6063-T5
 Finish : Anodized / Clean

JWHAE0063

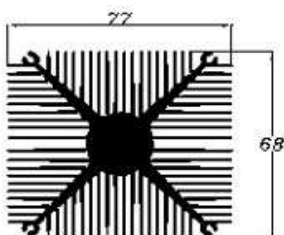

Dimensions (mm) : L77 / W68
 Material : AL 6063-T5
 Finish : Anodized / Clean

JWHAE0070

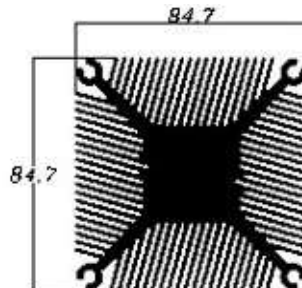

Dimensions (mm) : L84.7 / W84.7
 Material : AL 6063-T5
 Finish : Anodized / Clean

JWHAE0083

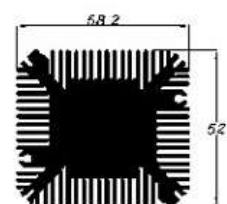

Dimensions (mm) : L58.2 / W52
 Material : AL 6063-T5
 Finish : Anodized / Clean

Extruded Profiles

EXTRUDED HEATSINKS

JWHAE0094

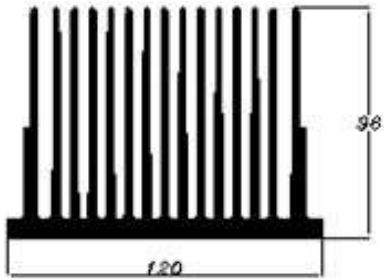

Dimensions (mm) : W120 / H98
 Material : AL 6063-T5
 Finish : Anodized / Clean

JWHAE0098

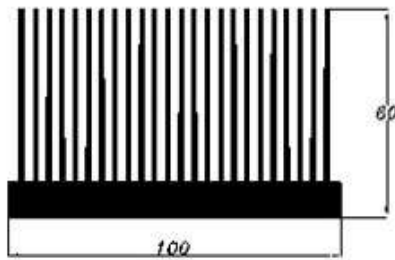

Dimensions (mm) : W100 / H80
 Material : AL 6063-T5
 Finish : Anodized / Clean

JWHAE0222

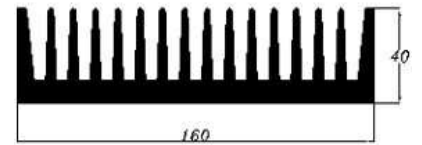

Dimensions (mm) : W160 / H40
 Material : AL 6063-T5
 Finish : Anodized / Clean

JWHAE0153

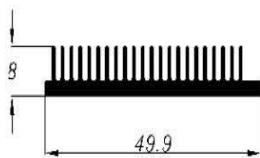

Dimensions (mm) : W49.9 / H8
 Material : AL 6063-T5
 Finish : Anodized / Clean

JWHAE0155

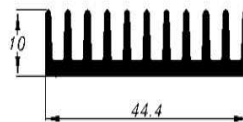

Dimensions (mm) : W44.4 / H10
 Material : AL 6063-T5
 Finish : Anodized / Clean

JWHAE0156

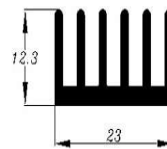

Dimensions (mm) : W23 / H12.3
 Material : AL 6063-T5
 Finish : Anodized / Clean

JWHAE0158

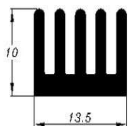

Dimensions (mm) : W13.5 / H10
 Material : AL 6063-T5
 Finish : Anodized / Clean

JWHAE0160

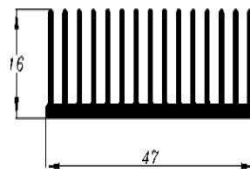

Dimensions (mm) : W47 / H16
 Material : AL 6063-T5
 Finish : Anodized / Clean

JWHAE0161

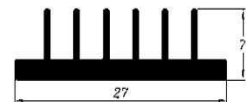

Dimensions (mm) : W27 / H7
 Material : AL 6063-T5
 Finish : Anodized / Clean

JWHAE0163

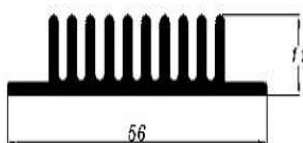

Dimensions (mm) : W56 / H11
 Material : AL 6063-T5
 Finish : Anodized / Clean

JWHAE0166

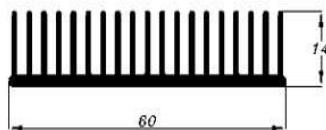

Dimensions (mm) : W60 / H14
 Material : AL 6063-T5
 Finish : Anodized / Clean

JWHAE0167

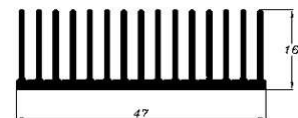

Dimensions (mm) : W47 / H16
 Material : AL 6063-T5
 Finish : Anodized / Clean

Extruded Profiles

EXTRUDED HEATSINKS

JWHAE0169

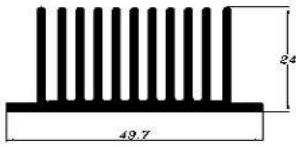

Dimensions (mm) : W49.7 / H24
 Material : AL 6063-T5
 Finish : Anodized / Clean

JWHAE0170

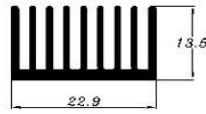

Dimensions (mm) : W22.9 / H13.5
 Material : AL 6063-T5
 Finish : Anodized / Clean

JWHAE0175

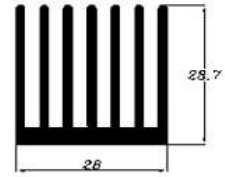

Dimensions (mm) : W28 / H28.7
 Material : AL 6063-T5
 Finish : Anodized / Clean

JWHAE0176

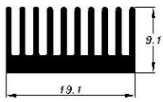

Dimensions (mm) : W19.1 / H9.1
 Material : AL 6063-T5
 Finish : Anodized / Clean

JWHAE0177

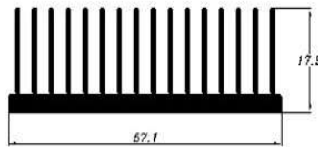

Dimensions (mm) : W57.1 / H17.9
 Material : AL 6063-T5
 Finish : Anodized / Clean

JWHAE0178

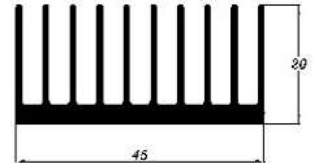

Dimensions (mm) : W45 / H20
 Material : AL 6063-T5
 Finish : Anodized / Clean

JWHAE0179

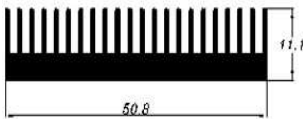

Dimensions (mm) : W50.8 / H11.1
 Material : AL 6063-T5
 Finish : Anodized / Clean

JWHAE0180

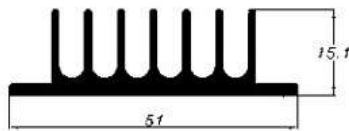

Dimensions (mm) : W51 / H15.1
 Material : AL 6063-T5
 Finish : Anodized / Clean

JWHAE0181

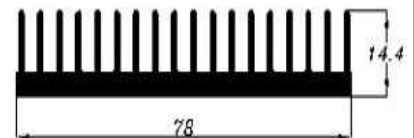

Dimensions (mm) : W78 / H14.4
 Material : AL 6063-T5
 Finish : Anodized / Clean

JWHAE0182

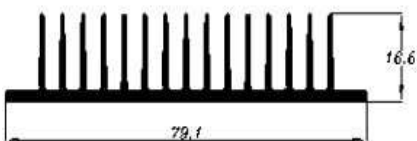

Dimensions (mm) : W79.1 / H16.6
 Material : AL 6063-T5
 Finish : Anodized / Clean

JWHAE0184

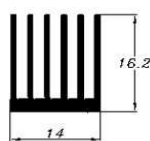

Dimensions (mm) : W14 / H16.2
 Material : AL 6063-T5
 Finish : Anodized / Clean

JWHAE0186

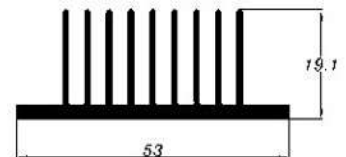

Dimensions (mm) : W53 / H19.1
 Material : AL 6063-T5
 Finish : Anodized / Clean

Extruded Profiles

EXTRUDED HEATSINKS

JWHAE0187



Dimensions (mm) : W57.3 / H11.5
Material : AL 6063-T5
Finish : Anodized / Clean

JWHAE0188

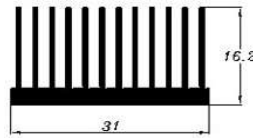

Dimensions (mm) : W31 / H16.2
Material : AL 6063-T5
Finish : Anodized / Clean

JWHAE0190

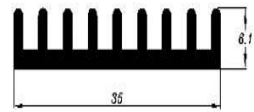

Dimensions (mm) : W35 / H6.1
Material : AL 6063-T5
Finish : Anodized / Clean

JWHAE0194

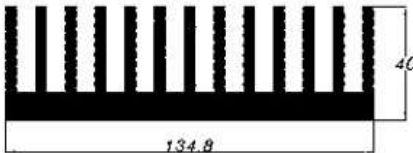

Dimensions (mm) : W134.8 / H40
Material : AL 6063-T5
Finish : Anodized / Clean

JWHAE0198

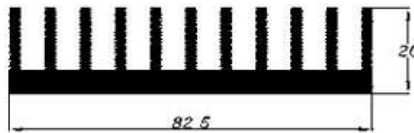

Dimensions (mm) : W82.5 / H20
Material : AL 6063-T5
Finish : Anodized / Clean

JWHAE0206



Dimensions (mm) : W116 / H6.6
Material : AL 6063-T5
Finish : Anodized / Clean

JWHAE0212



Dimensions (mm) : W90 / H14.7
Material : AL 6063-T5
Finish : Anodized / Clean

JWHAE0216

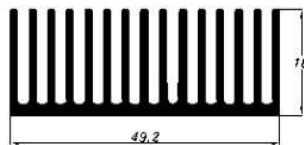

Dimensions (mm) : W49.2 / H18
Material : AL 6063-T5
Finish : Anodized / Clean

JWHAE0217

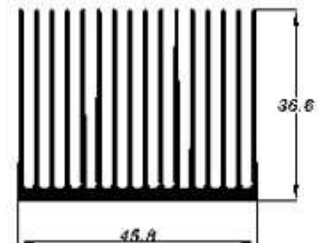

Dimensions (mm) : W45.8 / H36.8
Material : AL 6063-T5
Finish : Anodized / Clean

JWHAE0234

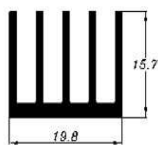

Dimensions (mm) : W19.8 / H15.7
Material : AL 6063-T5
Finish : Anodized / Clean

JWHAE0235

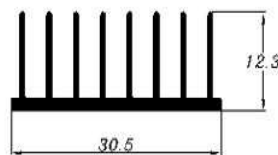

Dimensions (mm) : W30.5 / H12.3
Material : AL 6063-T5
Finish : Anodized / Clean

JWHAE0239

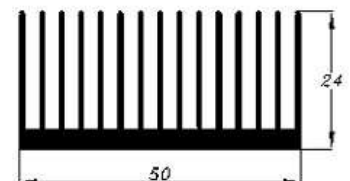

Dimensions (mm) : W50 / H24
Material : AL 6063-T5
Finish : Anodized / Clean

Extruded Profiles

EXTRUDED HEATSINKS

JWHAE0200

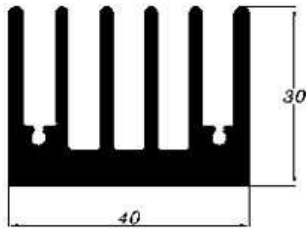

Dimensions (mm) : W40 / H30
 Material : AL 6063-T5
 Finish : Anodized / Clean

JWHAE0202

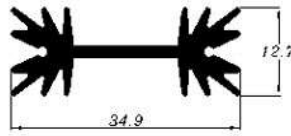

Dimensions (mm) : W34.9 / H12.7
 Material : AL 6063-T5
 Finish : Anodized / Clean

JWHAE0204

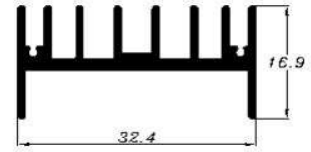

Dimensions (mm) : W32.4 / H16.9
 Material : AL 6063-T5
 Finish : Anodized / Clean

JWHAE0205

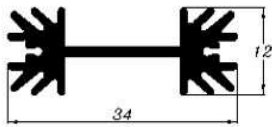

Dimensions (mm) : W34 / H12
 Material : AL 6063-T5
 Finish : Anodized / Clean

JWHAE0208

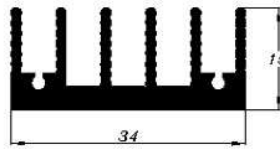

Dimensions (mm) : W34 / H15
 Material : AL 6063-T5
 Finish : Anodized / Clean

JWHAE0215

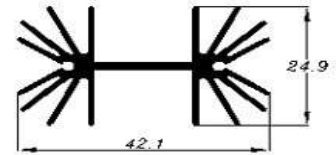

Dimensions (mm) : W42.1 / H24.9
 Material : AL 6063-T5
 Finish : Anodized / Clean

JWHAE0220

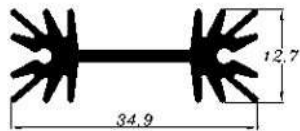

Dimensions (mm) : W34.9 / H12.7
 Material : AL 6063-T5
 Finish : Anodized / Clean

JWHAE0221

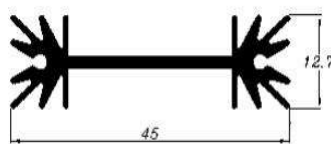

Dimensions (mm) : W45 / H12.7
 Material : AL 6063-T5
 Finish : Anodized / Clean

JWHAE0226

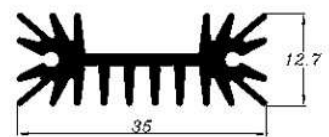

Dimensions (mm) : W35 / H12.7
 Material : AL 6063-T5
 Finish : Anodized / Clean

JWHAE0230

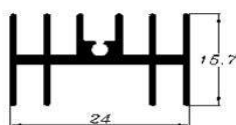

Dimensions (mm) : W24 / H15.7
 Material : AL 6063-T5
 Finish : Anodized / Clean

JWHAE0236

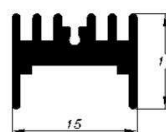

Dimensions (mm) : W15 / H11
 Material : AL 6063-T5
 Finish : Anodized / Clean

JWHAE0269

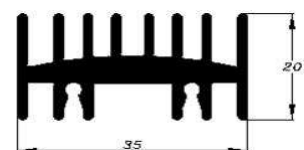

Dimensions (mm) : W35 / H20
 Material : AL 6063-T5
 Finish : Anodized / Clean

FEATURES :

- Be cmbined from two parts - the base, and stamped fin.
- Be made using a die stamping process.
- Could be stamped into a broad range of geometries and thicknesses.
- This technique offers a low non-recurring engineering charge, prototype set up costs are minimal.



JBHAS0041

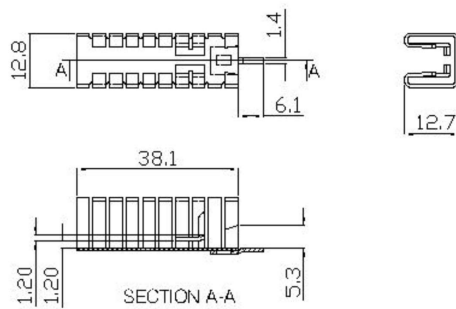

Dimensions (mm) : L38.1 / W12.8 / H12.7 / T0.8
 Material : AL 5052
 Finish / Color : Anodized Black

JBHAS0042

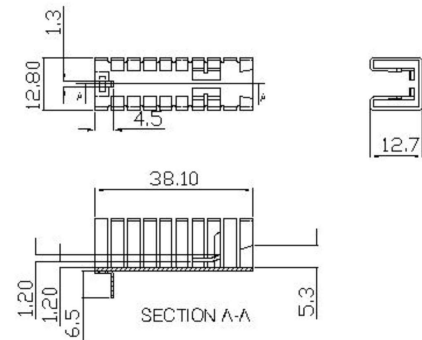

Dimensions (mm) : L38.1 / W12.8 / H12.7 / T0.8
 Material : AL 5052
 Finish / Color : Anodized Black

JBHAS0043

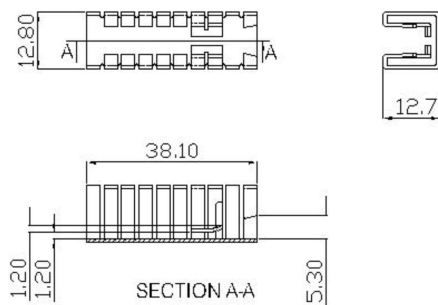

Dimensions (mm) : L38.1 / W12.8 / H12.7 / T0.8
 Material : AL 5052
 Finish / Color : Anodized Black

JBHAS0045

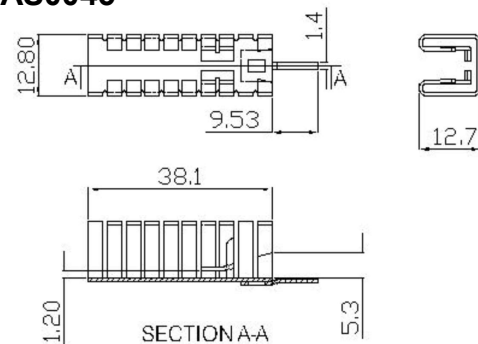

Dimensions (mm) : L38.1 / W12.8 / H12.7 / T0.8
 Material : AL 5052
 Finish / Color : Anodized Black

JBHAS0046

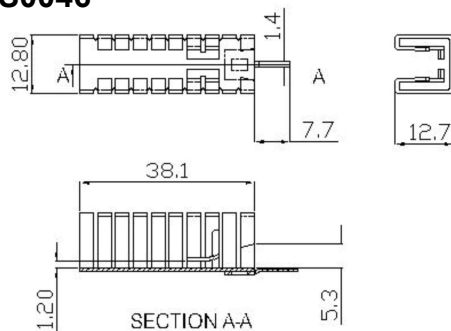

Dimensions (mm) : L38.1 / W12.8 / H12.7 / T0.8
 Material : AL 5052
 Finish / Color : Anodized Black

JBHAS0181

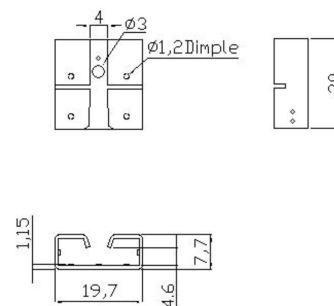

Dimensions (mm) : L20 / W19.7 / H7.7 / T0.8
 Material : AL 5052
 Finish / Color : Anodized Black

JBHAS0191

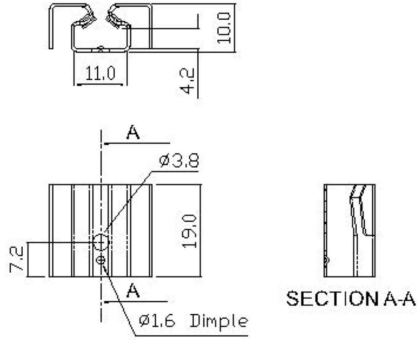

Dimensions (mm) : L19 / W21.2 / H10 / T0.8
 Material : AL 5052
 Finish / Color : Anodized Black

JBHAS0211

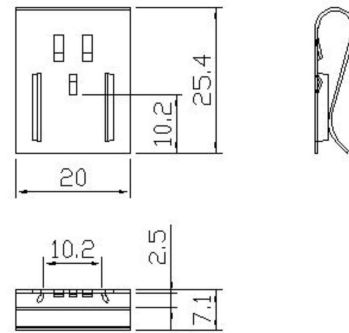

Dimensions (mm) : L25.4 / W20 / H7.1 / T0.8
 Material : AL 5052
 Finish / Color : Anodized Black

JBHAS0341

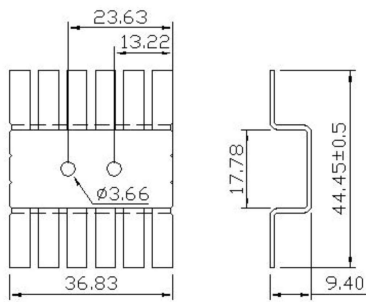

Dimensions (mm) : L36.8 / W44.5 / H9.4 / T1.0
 Material : AL 1050
 Finish / Color : Anodized Black

JBHAS0963

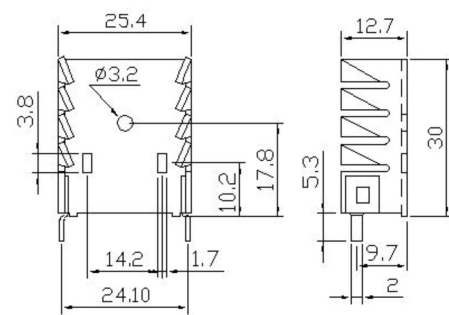

Dimensions (mm) : L30 / W25.4 / H12.7 / T1.2
 Material : AL 1050
 Finish / Color : Anodized Black

JBHAS1151

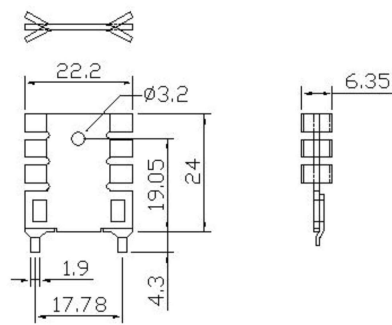

Dimensions (mm) : L24 / W22.2 / H6.35 / T1.2
 Material : AL 1050
 Finish / Color : Anodized Black

JBHAS1341

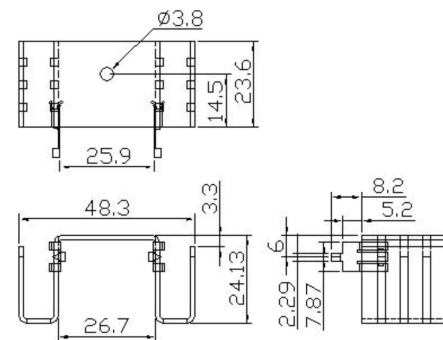

Dimensions (mm) : L23.6 / W48.3 / H24.1 / T1.2
 Material : AL 1050
 Finish / Color : Anodized Black

JBHAS1401

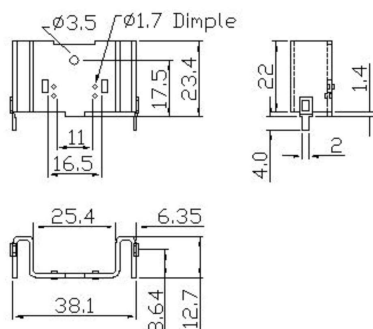

Dimensions (mm) : L23.4 / W38.1 / H12.7 / T1.2
 Material : AL 1050
 Finish / Color : Anodized Black

JBHAS2141

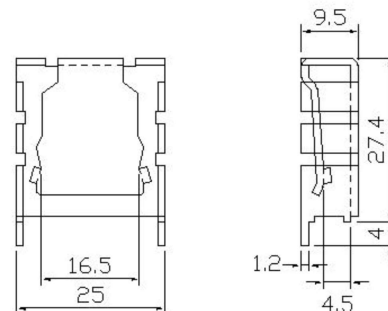

Dimensions (mm) : L27.4 / W25 / H9.5 / T1.2
 Material : AL 1050
 Finish / Color : Anodized Black

JBHAS2501

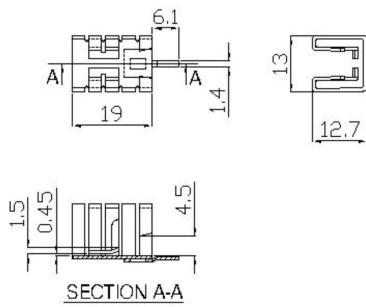

Dimensions (mm) : L18.8 / W22.29 / H9.5 / T1
 Material : AL 1050
 Finish / Color : Anodized Black

JBHAS2222

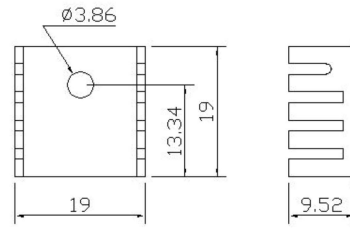

Dimensions (mm) : L19 / W19 / H9.5 / T1.2
 Material : AL 1050
 Finish / Color : Anodized Black

JBHAS2371

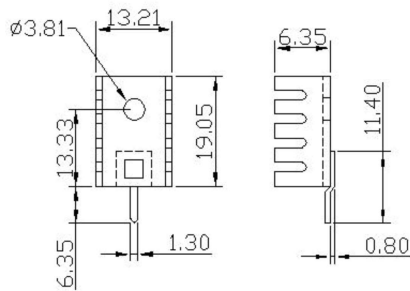

Dimensions (mm) : L19.05 / W13.2 / H6.35 / T1.2
 Material : AL 1050
 Finish / Color : Anodized Black

JBHAS2372

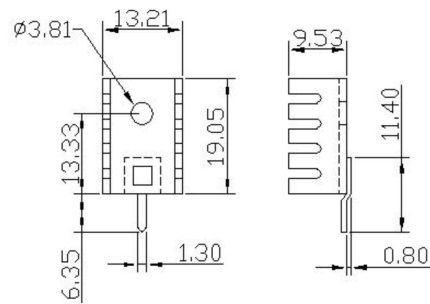

Dimensions (mm) : L19.05 / W13.2 / H9.53 / T1.2
 Material : AL 1050
 Finish / Color : Anodized Black

JBHAS2373

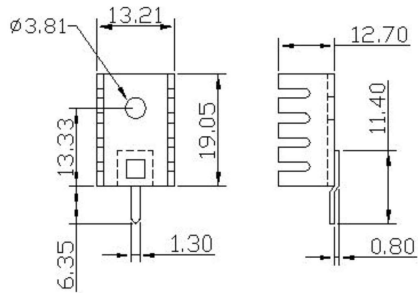

Dimensions (mm) : L19.05 / W13.2 / H12.7 / T1.2
 Material : AL 1050
 Finish / Color : Anodized Black

JBHAS2391

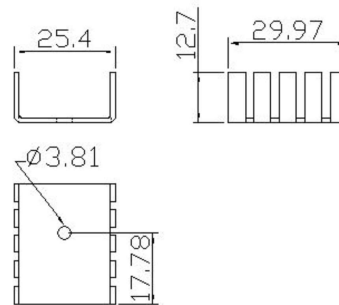

Dimensions (mm) : L30 / W25.4 / H12.7 / T1.2
 Material : AL 1050
 Finish / Color : Anodized Black

JBHAS2392

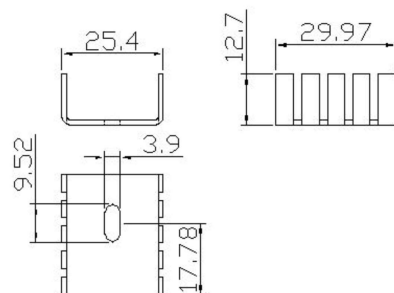

Dimensions (mm) : L30 / W25.4 / H12.7 / T1.2
 Material : AL 1050
 Finish / Color : Anodized Black

JBHAS2393

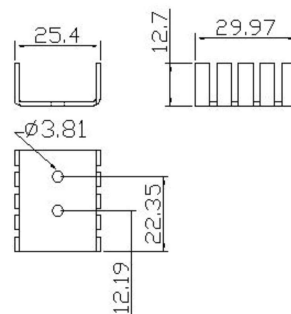

Dimensions (mm) : L30 / W25.4 / H12.7 / T1.2
 Material : AL 1050
 Finish / Color : Anodized Black

JBHAS2394

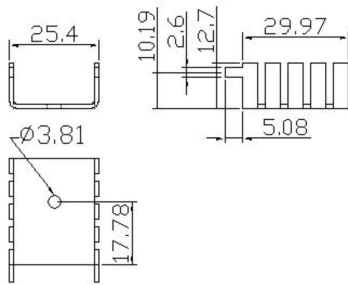

Dimensions (mm) : L30 / W25.4 / H12.7 / T1.2
 Material : AL 1050
 Finish / Color : Anodized Black

JBHAS2395

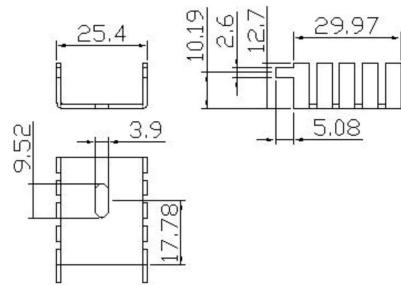

Dimensions (mm) : L30 / W25.4 / H12.7 / T1.2
 Material : AL 1050
 Finish / Color : Anodized Black

JBHAS2396

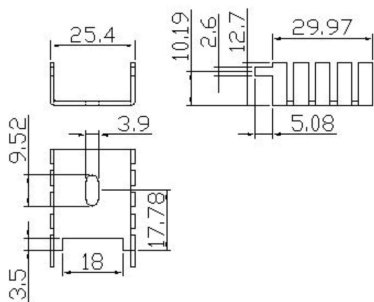

Dimensions (mm) : L30 / W25.4 / H12.7 / T1.2
 Material : AL 1050
 Finish / Color : Anodized Black

JBHAS2397

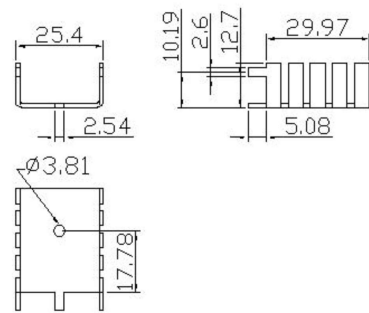

Dimensions (mm) : L30 / W25.4 / H12.7 / T1.2
 Material : AL 1050
 Finish / Color : Anodized Black

JBHAS2398

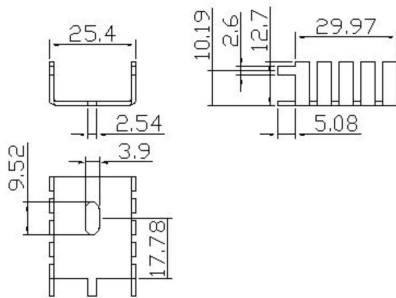

Dimensions (mm) : L30 / W25.4 / H12.7 / T1.2
 Material : AL 1050
 Finish / Color : Anodized Black

JBHAS2401

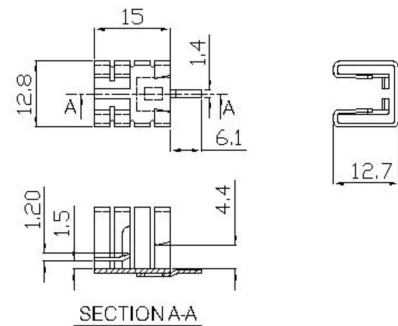

Dimensions (mm) : L15 / W12.8 / H12.7 / T0.8
 Material : AL 5052
 Finish / Color : Anodized Black

JBHAS2403

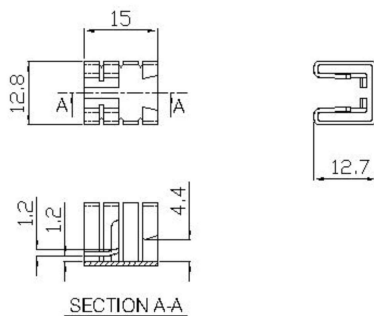

Dimensions (mm) : L15 / W12.8 / H12.7 / T0.8
 Material : AL 5052
 Finish / Color : Anodized Black

JBHAS2404

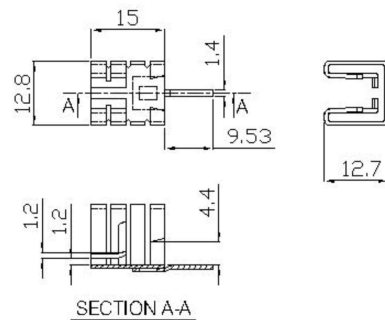

Dimensions (mm) : L15 / W12.8 / H12.7 / T0.8
 Material : AL 5052
 Finish / Color : Anodized Black

JBHAS2422

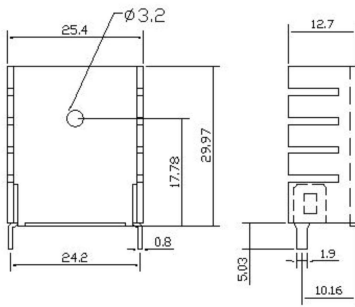

Dimensions (mm) : L30 / W25.4 / H12.7 / T1.2
 Material : AL 1050
 Finish / Color : Anodized Black

JBHAS2426

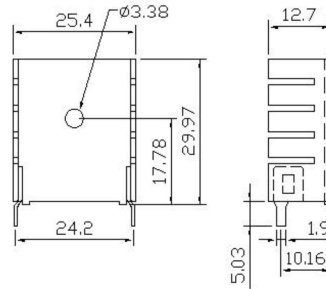

Dimensions (mm) : L30 / W25.4 / H12.7 / T1.2
 Material : AL 1050
 Finish / Color : Anodized Black

JBHAS2522

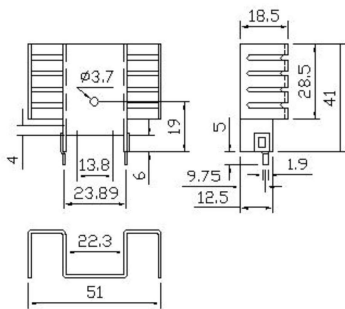

Dimensions (mm) : L41 / W51 / H18.5 / T1.2
 Material : AL 1050
 Finish / Color : Anodized Black

JBHAS2531

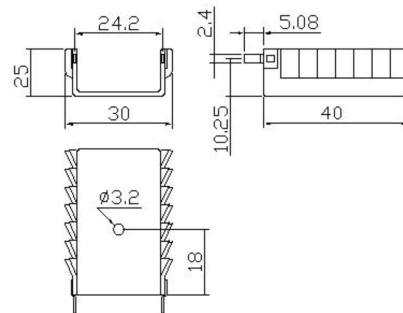

Dimensions (mm) : L40 / W30 / H25 / T1.2
 Material : AL 1050
 Finish / Color : Anodized Black

JBHAS2541

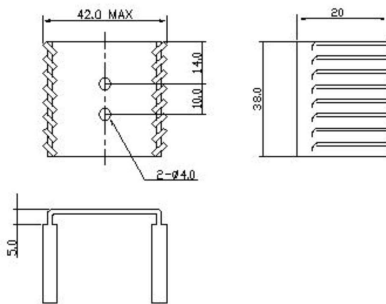

Dimensions (mm) : L38 / W42 / H20 / T1.5
 Material : AL 1050
 Finish / Color : Anodized Black

JBHAS2542

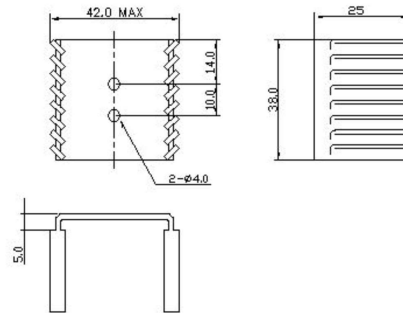

Dimensions (mm) : L38 / W42 / H25 / T1.5
 Material : AL 1050
 Finish / Color : Anodized Black

JBHAS2544

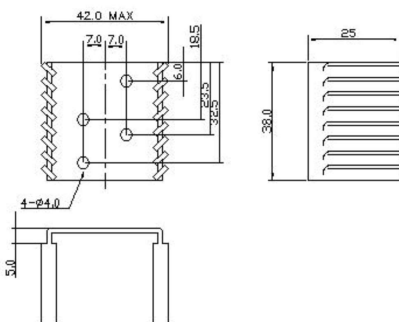

Dimensions (mm) : L38 / W42 / H25 / T1.5
 Material : AL 1050
 Finish / Color : Anodized Black

JBHAS8071

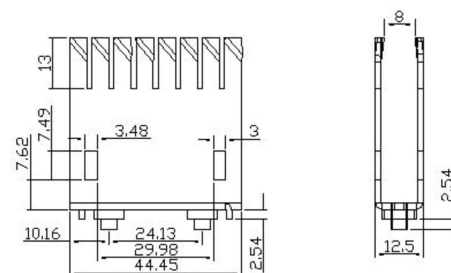

Dimensions (mm) : L44.5 / W12.5 / H44.5 / T1.6
 Material : AL 1050
 Finish / Color : Anodized Black

JBHAS2601

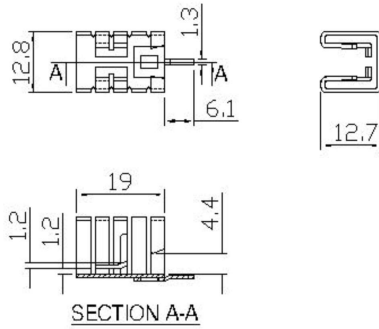

Dimensions (mm) : L19 / W12.8 / H12.7 / T0.8
 Material : AL 5052
 Finish / Color : Anodized Black

JBHAS2602

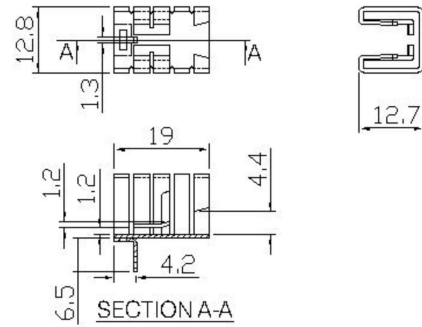

Dimensions (mm) : L19 / W12.8 / H12.7 / T0.8
 Material : AL 5052
 Finish / Color : Anodized Black

JBHAS2603

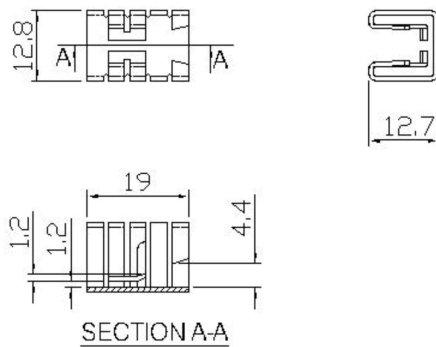

Dimensions (mm) : L19 / W12.8 / H12.7 / T0.8
 Material : AL 5052
 Finish / Color : Anodized Black

JBHAS2604

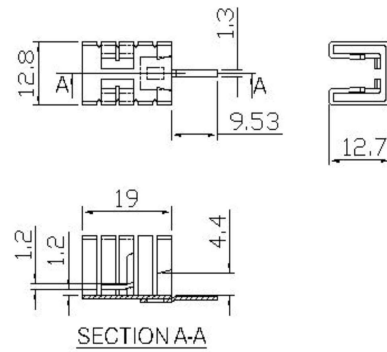

Dimensions (mm) : L19 / W12.8 / H12.7 / T0.8
 Material : AL 5052
 Finish / Color : Anodized Black

JBHAS2611

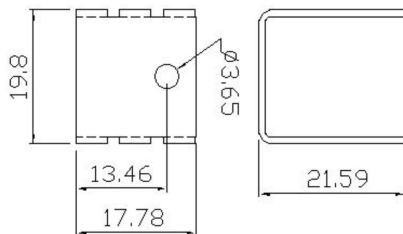

Dimensions (mm) : L17.8 / W19.8 / H21.6 / T1
 Material : AL 1050
 Finish / Color : Anodized Black

JBHAS2621

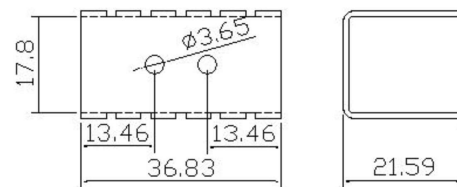

Dimensions (mm) : L36.8 / W17.8 / H21.6 / T1
 Material : AL 1050
 Finish / Color : Anodized Black

JBHAS2631

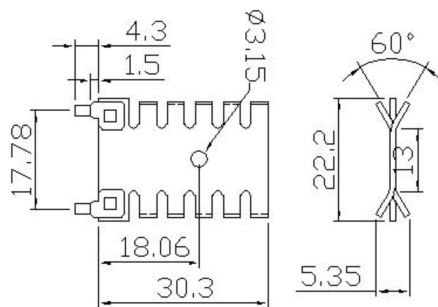

Dimensions (mm) : L30.3 / W22.2 / H5.35 / T1
 Material : AL 1050
 Finish / Color : Anodized Black

JBHAS2651

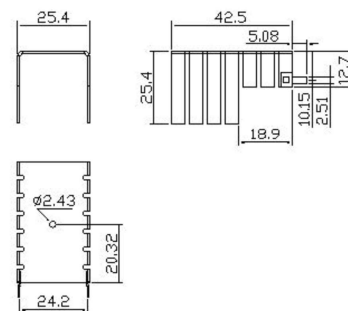

Dimensions (mm) : L42.5 / W25.4 / H25.4 / T1.2
 Material : AL 1050
 Finish / Color : Anodized Black

JBHAS2652

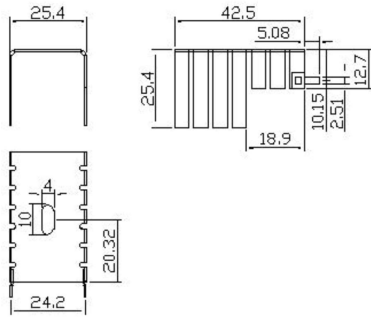

Dimensions (mm) : L42.5 / W25.4 / H25.4 / T1.2
 Material : AL 1050
 Finish / Color : Anodized Black

JBHAS2653

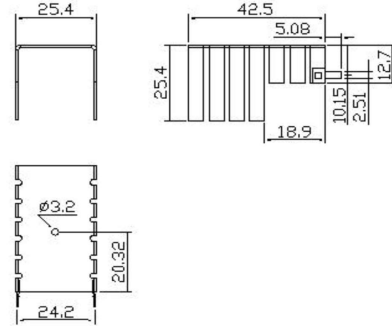

Dimensions (mm) : L42.5 / W25.4 / H25.4 / T1.2
 Material : AL 1050
 Finish / Color : Anodized Black

JBHAS2821

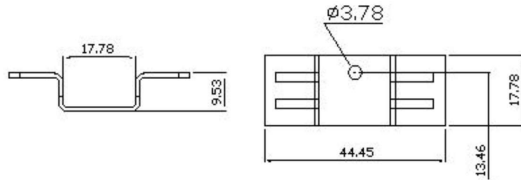

Dimensions (mm) : L17.8 / W44.5 / H9.5 / T1
 Material : AL 1050
 Finish / Color : Anodized Black

JBHAS2852

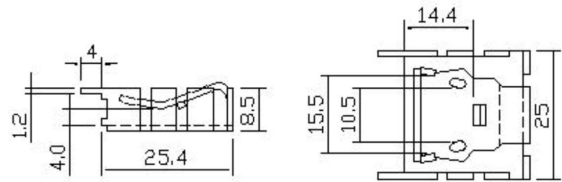

Dimensions (mm) : L25.4 / W25 / H8.5 / T1.2
 Material : AL 5052
 Finish / Color : Anodized Black

JBHAS2051

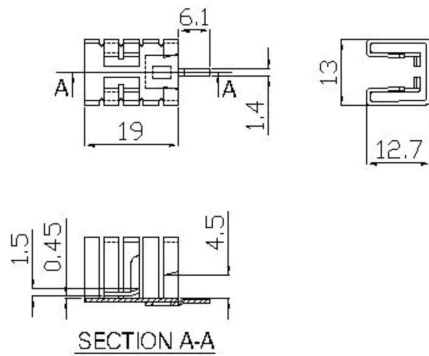

Dimensions (mm) : L19 / W13 / H12.7 / T0.8
 Material : AL 5052
 Finish / Color : Anodized Black

JBHAS2281

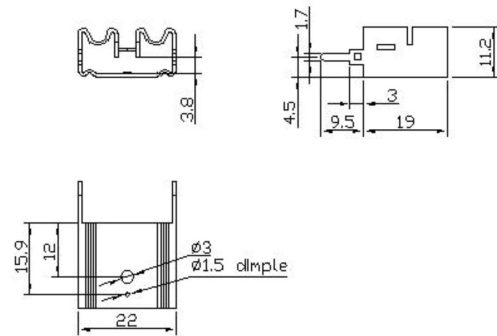

Dimensions (mm) : L19 / W22 / H11.2 / T0.8
 Material : AL 5052
 Finish / Color : Anodized Black

JBHAS2291

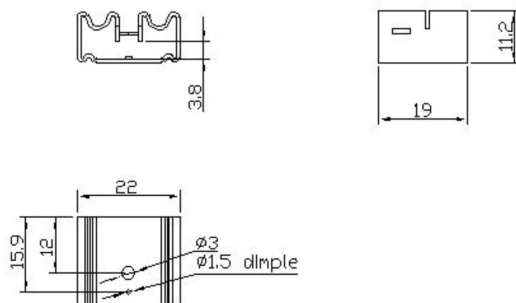

Dimensions (mm) : L19 / W22 / H11.2 / T0.8
 Material : AL 5052
 Finish / Color : Anodized Black

JBHAS0161

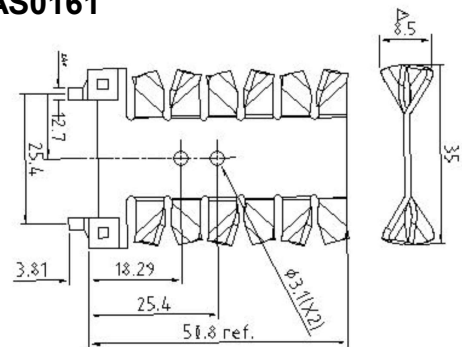

Dimensions (mm) : L50.8 / W35 / H8.5 / T1.2
 Material : AL 1050
 Finish / Color : Anodized Black

Clips

JBASS0041

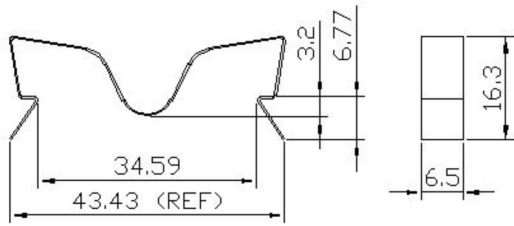

Dimensions (mm) : L6.5 / W43.43 / H16.3 / T0.5
 Material : SUS301 Finish : Clean
 For : JBHAE8011 / JBHAE8012 / JBHAE8013 / JBHAE8014
 JBHAE8016 / JBHAE8017 / JBHAE8018 / JBHAE8019

JBASS0421

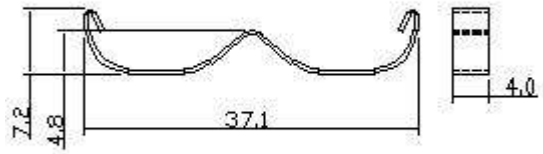

Dimensions (mm) : L4 / W37.1 / H7.2 / T0.4
 Material : SUS301
 Finish : Clean
 For : JBHAE2872 / JBHAE2873 / JBHAE2874 / JBHAE2875

JBASS0441

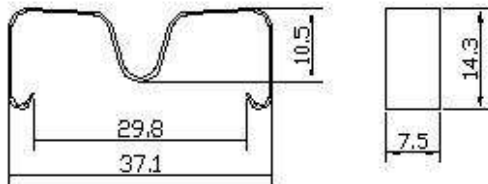

Dimensions (mm) : L7.5 / W37.1 / H14.3 / T0.4
 Material : SUS301
 Finish : Clean
 For : JBHAE0361 / JBHAE0362 / JBHAE0363

JBASS0061

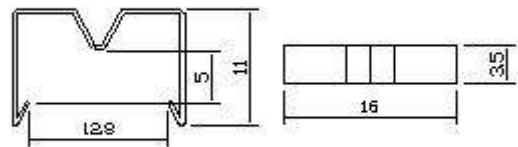

Dimensions (mm) : L3.5 / W16 / H11 / T0.4
 Material : SUS301
 Finish : Clean
 For : JBHAS2522

JBASS0071

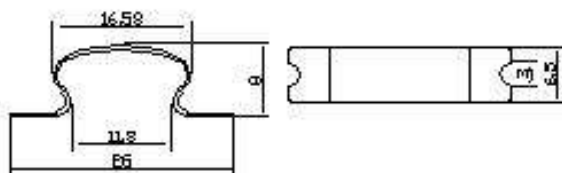

Dimensions (mm) : L6.5 / W26 / H8 / T0.4
 Material : SUS301 Finish : Clean
 For : JBHAE8110 / JBHAE8111 / JBHAE8112 / JBHAE8113 /
 JBHAE8114

JBASS0081

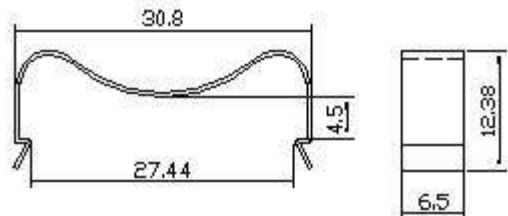

Dimensions (mm) : L6.5 / W30.8 / H12.38 / T0.4
 Material : SUS301
 Finish : Clean
 For : JBHAS8071

JBASS0101

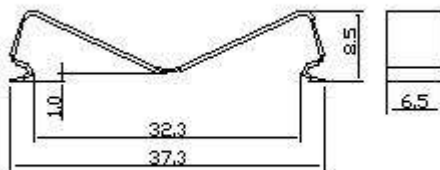

Dimensions (mm) : L6.5 / W37.3 / H8.5 / T0.4
 Material : SUS301
 Finish : Clean
 For : JBHAE2012 / JBHAE2013 / JBHAE2014 / JBHAE2015

JBASS0141

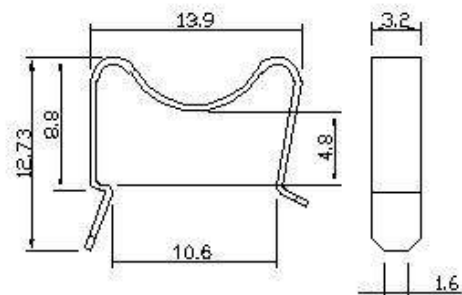

Dimensions (mm) : L3.2 / W13.9 / H12.73 / T0.4
 Material : SUS301
 Finish : Clean
 For : JBHAS0963