

REVISIONS			
REV.	COMMENT	DATE	APPROVED
0	INITIAL RELEASE	2023-03-30	CHRIS

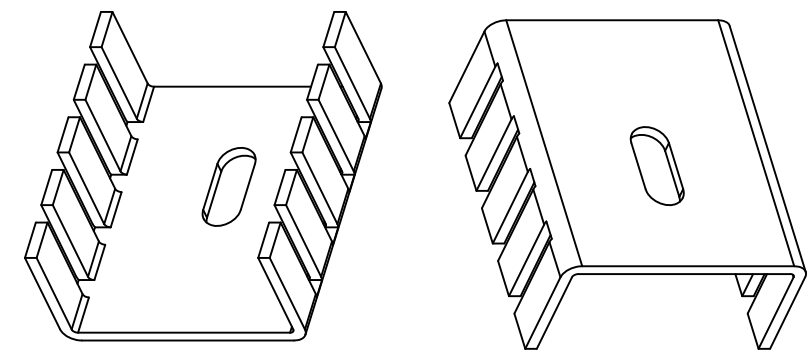

ISOMETRIC VIEW
SCALE 1:1

- NOTES:
- THIS DRAWING CONTAINS OVERALL DIMENSIONS ONLY. REFER TO 3D CAD DATABASE FOR COMPLETE PART INFORMATION.
 - PARTS TO BE CLEAN AND FREE OF CRACKS, FOREIGN MATTER. NO OIL OR LUBRICANTS ON THE SURFACE.
 - ALL DIMENSIONS SHOWN SHALL BE CHECKED AT FIRST ARTICLE INSPECTION.
 - REMOVE ALL BURRS AND SHARP EDGES.
 - FINISHED PRODUCT TO BE RoHS COMPLIANT.
 - TOLERANCE: $\pm 0.50\text{mm}$

DIMENSIONAL TOLERANCE		
DECIMAL PLACES	MILLIMETERS	INCHES
.	-	-
.X	-	-
.XX	-	-
UNLESS OTHERWISE SPECIFIED		
ANGULAR DIMENSIONS	THIRD ANGLE PROJECTION	
$\pm 1.0^\circ$		
SCALE	UNIT	SIZE
1:1	mm	A4

DRAWN	SIDNEY
CHECKED	CHRIS
APPROVED	CHRIS

TITLE	STAMPED HEAT SINK	
MATERIAL	AL 1050	
FINISH	BLACK ANODIZE	
CUS. PART NO.		CUS. REV.
PART NO.	JBHAS2392	REV. 0

SHEET	DATE
1 OF 1	2023-03-30