

REVISIONS			
REV.	COMMENT	DATE	APPROVED
0	INITIAL RELEASE	2023-05-30	CHRIS

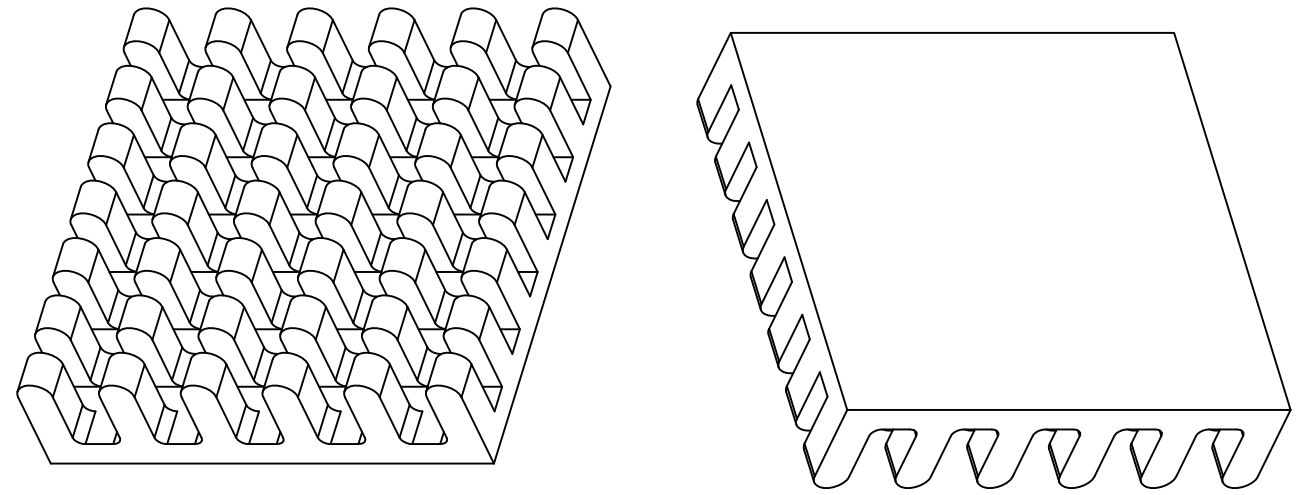

ISOMETRIC VIEW
SCALE 2:1

- NOTES:
1. THIS DRAWING CONTAINS OVERALL DIMENSIONS ONLY. REFER TO 3D CAD DATABASE FOR COMPLETE PART INFORMATION.
 2. PARTS TO BE CLEAN AND FREE OF CRACKS, FOREIGN MATTER. NO OIL OR LUBRICANTS ON THE SURFACE.
 3. ALL DIMENSIONS SHOWN SHALL BE CHECKED AT FIRST ARTICLE INSPECTION.
 4. REMOVE ALL BURRS AND SHARP EDGES.
 5. FINISHED PRODUCT TO BE RoHS COMPLIANT.
 6. TOLERANCE: $\pm 0.30\text{mm}$

DIMENSIONAL TOLERANCE		
DECIMAL PLACES	MILLIMETERS	INCHES
.	-	-
.X	-	-
.XX	-	-
UNLESS OTHERWISE SPECIFIED		
ANGULAR DIMENSIONS	THIRD ANGLE PROJECTION	
$\pm 1.0^\circ$		
SCALE	UNIT	SIZE
2:1	mm	A4

DRAWN	SIDNEY
CHECKED	CHRIS
APPROVED	CHRIS

TITLE	BGA HEAT SINK	
MATERIAL	AL 6063-T5	
FINISH	BLACK ANODIZE	
CUS. PART NO.		CUS. REV.
PART NO.	JBHAE2301	REV. 0

		SHEET	DATE
		1 OF 1	2023-05-30